

LUSTO S461

Karri Monni | 2023



LUSTO

Karri Monni | 2023

We observe them, we admire them, we walk and breathe among them and we feel better. They are the trees, they are nature's most complex and meaningful structure. Karri Monni was inspired by this inexhaustible vitality and beauty when he designed LUSTO, a new stool that fits beautifully into Lapalma's forest/catalogue. First of all the name, in Finnish the circle that marks in the trunk the progress of the years. And the design also speaks of natural growth, which gradually brings together the bases, accommodates the "circle" of the footrest and opens into the foliage of an extremely comfortable seat. In two versions, natural and black, without declaring joints but developing into a continuum of roots, trunk and branches, LUSTO is a tribute to nature. And every moment spent in its company, at home, in a restaurant, in an airport café, is a small circle that adds to the pleasure of our conviviality.



LUSTO

Karri Monni | 2023

S461 4-leg stool made of solid ash wood painted in various colours

4-leg stool made of solid ash wood painted in various colours. Footrest in powder-coated steel. Painted solid ash wood seat or fully upholstered in fabric, leather or eco-leather. Nylon feet with felt or plastic insert.

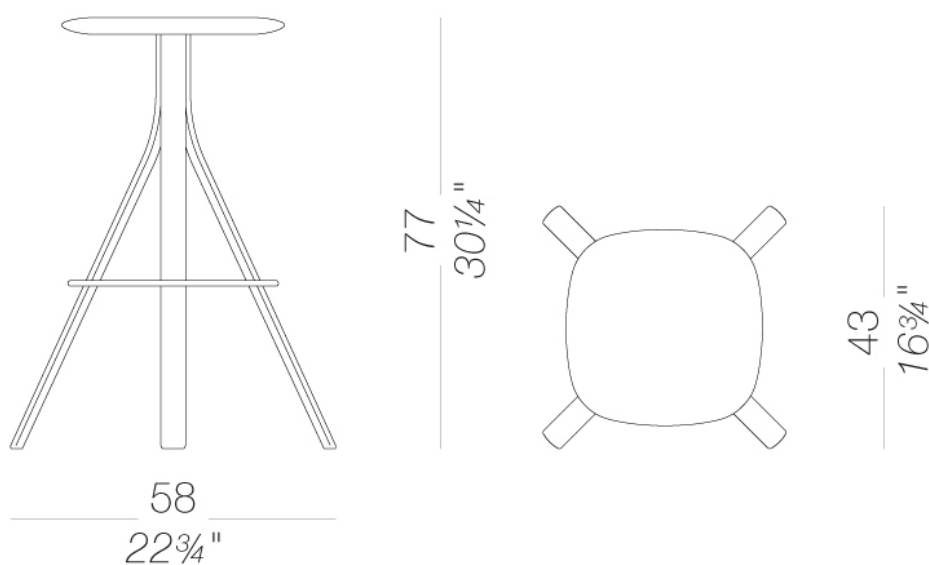

LUSTO S461

Karri Monni | 2023

upholstery

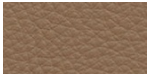

soft-leather
Soft-leather
17 Colors

frame

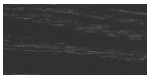

wood
black open pore
1 Colors



wood
natural ash
1 Colors

seat

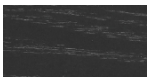

wood
black open pore
1 Colors



wood
natural ash
1 Colors



fabric
Jet - Grade A
66 Colors



fabric
Maya - Grade A
43 Colors

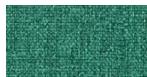

fabric
Medley - Grade A
37 Colors



fabric
Capture - Grade B
60 Colors



fabric
Crisp - Grade B
40 Colors



ecoleather
Valencia - Grade B
72 Colors



fabric
Iris - Grade B
34 Colors



fabric
Canvas 2 - Grade C
45 Colors



fabric
Fiord 2 - Grade C
39 Colors



fabric
Hallingdal 65 - Grade C
58 Colors



fabric
Remix 3 - Grade C
72 Colors



fabric
Tonica 2 - Grade C
39 Colors



fabric
Divina MD - Grade D
27 Colors



fabric
Divina Melange 3 - Grade D
38 Colors



fabric
Steelcut Trio 3 - Grade D
54 Colors

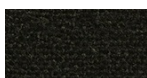

fabric
Main Line Flax - Grade B
57 Colors



fabric
Chili - Grade A
47 Colors



fabric
Blazer - Grade C
77 Colors



fabric
Umber - Grade B
36 Colors

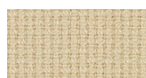

fabric
Nobel - Grade C
30 Colors



fabric
Naveli - Grade C
24 Colors

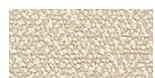

fabric
Fiocco - Grade B
34 Colors

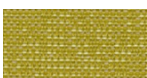

fabric
Atrium - Grade C
16 Colors



fabric
Panama - Grade A
48 Colors



fabric
Sorrento - Grade B
22 Colors

LUSTO S461

Karri Monni | 2023

consult the portfolio for the range of colors, fabrics, eco-leather, soft-leather.

use and maintenance instructions

Clean all parts in wood, leather, fabric and metal with a damp cloth or a diluted neutral cleaner. Do not use cleaners with alcohol, bleach, solvent or abrasive products. Any liquid spilt on the product must be wiped up immediately. When lifting or moving the product, hold it on the structure and not under the seat. The product should not be subjected to unbalanced weights, as it is designed for a proper rest on the foothold (on four legs or on the base). Our company relieves from any responsibility in case of damage caused to fragile floors. Avoid any improper use of the product: do not step on the product, on the footrest or on the armrests. Avoid any movements that could compromise the proper functionality of the product or the safety of the users. Wood and leather, being natural materials, could be easily damaged. Small impurities or imperfections are within quality standard range. Do not expose the product to weather conditions or atmospheric agents, nor to heat sources over 40°C. Also products for outdoor use could be afflicted by atmospheric agents. The product could undergo possible exterior changes due to particular exposure to heat, humidity and saltiness. An appropriate and frequent maintenance and cleaning of the product enhances its durability. The product could change colour and shade, if exposed to direct sunlight. Maintenance has to be carried out by experienced staff. Dispose of the package only after assembling the product, in order to avoid the loss of ironmongery and components. Once the product has been dismantled, the product itself or its components must be given to the public garbage disposal system, according to the legislation in force.