



FUTURE WORKPLACE

Your Furniture & Flooring Partner





*"Furniture is the poetry of space—transforming emptiness into purpose,
and moments into meaning."*

Introduction

F

"**Forward**" - Symbolizing innovation and evolution in workplace furniture solution.

W

"**Wellbeing**" - Emphasizing the focus on creating ergonomic and comfortable workspaces.

P

"**Precision**" - Reflecting the attention to detail and craftsmanship in your furniture designs.

Our Journey So Far..

2020-22

We set out to deliver best-in-class workplace furniture solutions across the UAE, backed by over a decade of industry expertise. With a clear vision for GCC expansion, we marked a key milestone by opening our first showroom on Sheikh Zayed Road in 2022.

2023-25

We strengthened our presence by building strong collaborations with leading international brands, expanding our team, and enhancing operational efficiency. In 2024, we further accelerated our growth by opening branch offices in Abu Dhabi and Riyadh.

2026 & Beyond

We continue to drive design innovation while strengthening our sustainability initiatives and digital capabilities. Our focus remains on delivering an elevated customer experience, expanding into global markets, and maintaining the highest standards of quality and craftsmanship.

Our Commitment

- 01.** We are committed to healthy and productive work environment. We supply sustainable, recyclable and green products with the help of our manufacturers.
- 02.** We are specialized in innovative workplace design and furniture by bringing a modern touch to your office workspace.
- 03.** Committed to provide workplace furniture that delivers great value by combining modern design, high quality and exceptional service.



Our Services



Space Planning and Designing



Design Specification Visualization



Project Execution

We transform empty spaces into functional, human-centric environments tailored to your workflow. Our space planning blends precision, creativity, and the right furniture to bring your vision to life.

We translate your thoughts into joyful visuals and spot-on specifications. It's like seeing your dream space wink at you before it's built.

Project execution guided by clarity, craftsmanship, and absolute reliability. A minimal, premium approach that ensures every element falls perfectly into place.

Our Expertise



Commercial

We create inspiring and efficient office environments that enhance productivity and reflect modern workplace needs. Clients can choose from an extensive range of desking systems, ergonomic seating, storage solutions, conference tables, and premium furniture sourced from our trusted global partners.



Healthcare

Our healthcare furniture solutions combine comfort, functionality, and style. We provide medically approved, high-quality products designed to meet the demands of healthcare environments while ensuring elegance and long-lasting performance.



Hospitality

From reception areas to guest lounges, we offer bespoke furniture solutions that elevate the ambience, comfort, and overall guest experience in hospitality spaces.



Education

We specialize in designing and supplying comprehensive educational furniture solutions that transform learning spaces into innovative and collaborative environments. Our range offers versatility, durability, and high-quality service for institutions across all levels of education.

Our Global Key Partners

Desking



WALTER KNOLL

4MARIANI

DELLAROVERE
OFFICE & CONTRACT

uffix

narbutas

Jmm

Quadrifoglio Group

KÖNIG+
NEURATH

codutti
MADE IN ITALY SINCE 1954

.mdd

bralco

Seating

Humanscale

HAWORTH

INCLASS

B&T

DITRE
italia

Diemme.

LAMM

MIDJ

punt

lapalma
ITALY

innova

PEDRALI

ondarreta

marelli

Resol

true

viccarbe

Phone Booths & Accessories

VILAGRASA

WorkBooth

sitia



S / STANDARD SIZE

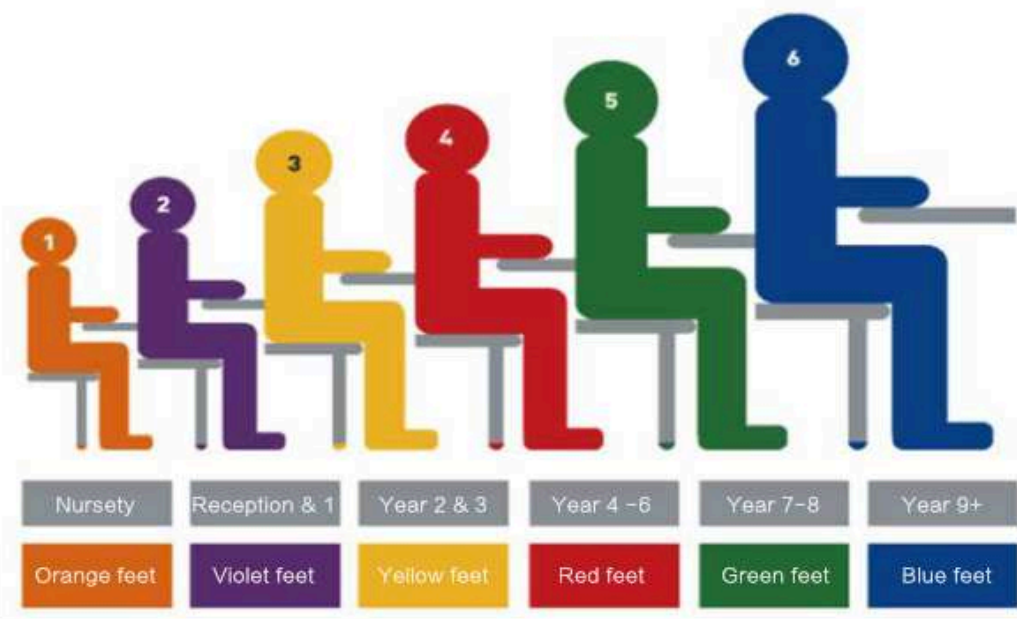

| Size Mark | 1 | 2 | 3 | 4 | 5 | 6 |
|--------------|-------|-------|-------|-------|-------|----------|
| Age Range | 3-4 | 4-6 | 6-8 | 8-11 | 11-14 | 14-Adult |
| Table Height | 460mm | 530mm | 580mm | 640mm | 700mm | 760mm |
| Chair Height | 260mm | 310mm | 360mm | 380mm | 420mm | 460mm |



The school that I want

By listening to what the school you imagine is like,
we can offer you the furniture you need.

A school with comfortable, versatile furniture that supports
the different educational dynamics that take place in it and
that absorbs the use and pace of the students. Beautiful, solid
and mobile furniture aligned with today's pedagogies.
We are your partner in furniture to create the school you want.

Escoltant com és l'escola que imagines podem
oferir-te els mobles que necessites.

Una escola amb mobles confortables, versàtils, que recolzin
les diferents dinàmiques educatives que s'hi desenvolupen
i absorbeixin l'ús i el ritme dels alumnes. Mobles bonics,
sòlids i mòbils alineats amb les pedagogies d'avui.
Som el teu partner de mobiliari per a crear l'escola que vols.



Colour for learning

The new line of furniture for learning features a colour palette inspired by nature. Colours of the sea, land and sky harmonize the design and offer a calm and comfortable beauty that responds to an expanding trend in the school sector.

La nova línia de mobles per a l'aprenentatge presenta una paleta de colors inspirats en la natura. Cromatismes del mar, la terra i el cel harmonitzen el disseny i ofereixen una bellesa calmada i confortable que dona resposta a una tendència en expansió en el sector escolar.

LIGHT GREY

A neutral and balanced colour. Light grey is associated with conservative and sophisticated meanings.

Un color neutre i equilibrat. El gris clar s'associa a opcions conservadores i sofisticades.



TERRACOTA

It's not a single colour, but a family of colours that resemble fired clay. It means "fired earth" and the component colours are typically orange and brown.

No es tracta d'un sol color, sino d'una família de colors que recorden l'argila cuita. La paraula significa "terra cuita" i els colors que la componen són habitualment el taronja i el marró.

OCRE

Possibly one of the oldest colours and a symbol of life. Some societies quite often associate it with life.

Possiblement un dels colors més antics i un símbol vital. Algunes societats l'associen habitualment amb la vida.



MINT

A freshening and welcoming hue associated with summer and water activities because of its similarity to sea shades and pools. It represents tranquillity, balance and calm.

És una tonalitat refrescant i acollidora associada a les activitats d'estiu i aquàtiques per la seva similitud amb les ombres del mar i les piscines. Representa tranquil·litat, equilibri i calma.

NAVY

Chromatic harmony is the equilibrium that one obtains when the right colours are combined. It is consonance, it is calm, it is a piano perfectly in tune.

L'harmonia cromàtica és l'equilibri que s'obté quan es combinen els colors adients. És consonància, és calma, és un piano perfectament afinat.



CHARCOAL

It has a great expressive value: highlights the forms, making them more elegant and sophisticated. It's the colour that combines in perfect harmony with all the others.

El color negre té un gran valor expressiu, ressalta les formes, fent-les més elegants i sofisticades. És el color que combina en perfecta harmonia amb tota la resta.



LEARNING SPACES

The joy of
growing and
expanding



The school is that friendly and safe space where understanding, creativity and feelings allow to discover both the world and oneself.

L'escola és l'espai amable i segur en què la comprensió, creativitat i sentiments permeten descobrir tant el món com a un mateix.



Dividing is adding.







Separating areas within the same space is easy with panels that also provide acoustic comfort. The learning environment has a deep impact on the educational results of all students. Shall we make the most of every square meter?

Separar zones en un mateix espai és fàcil amb panells que a més aporten confort acústic. L'entorn d'aprenentatge té un efecte profund en els resultats educatius de tots els alumnes. Treiem partit de cada metre quadrat?



54 m²



30

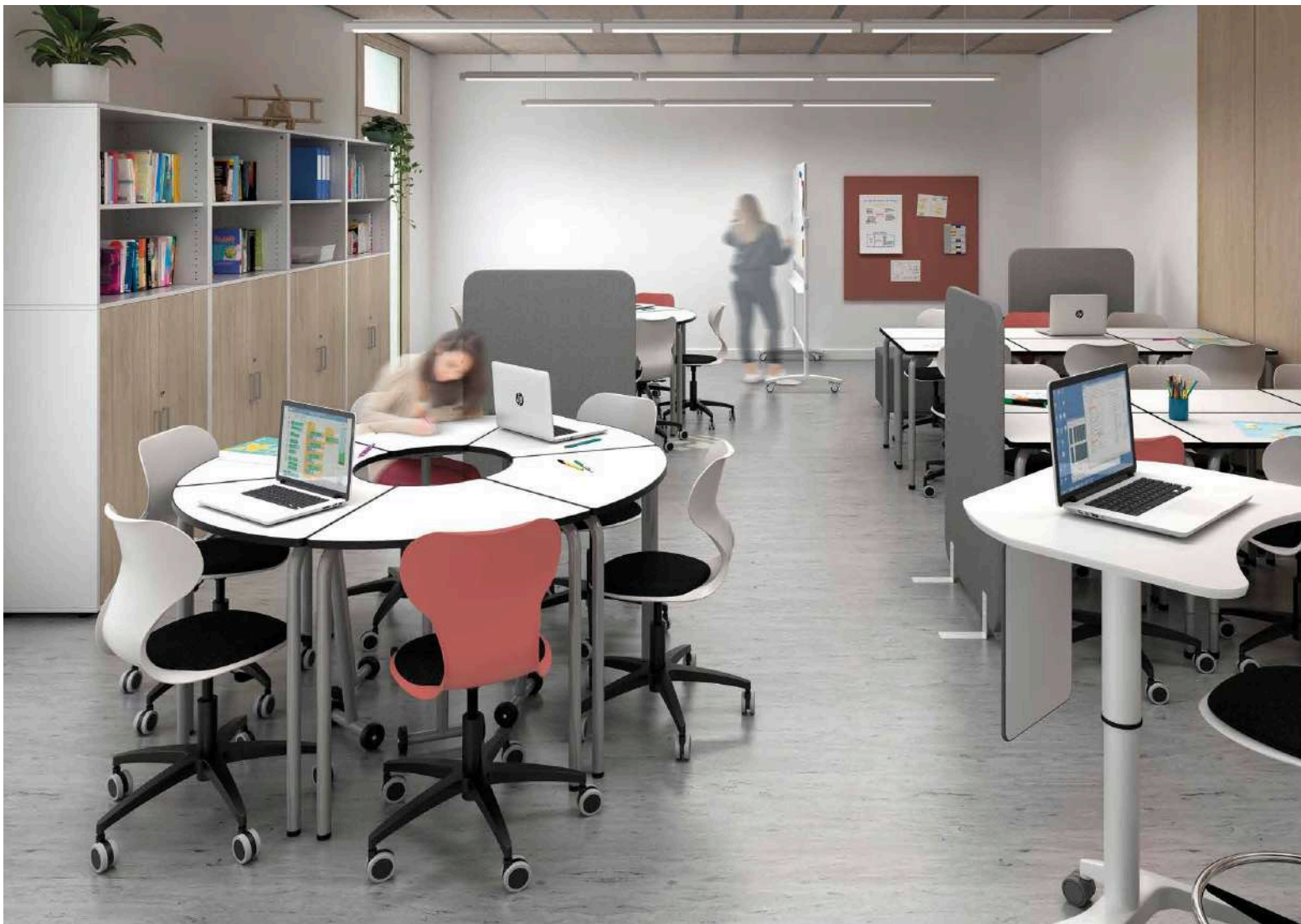



HEXA

The HEXA table is the paradigm of versatility and storage optimization.

La taula HEXA és el paradigma de la versatilitat i optimització de l'emmagatzematge.



SAMOS

SAMOS acoustic panels divide spaces and dampen sound, making communication easier.

Els panells acústics SAMOS separen espais i esmorteixen el so tot facilitant la comunicació.



MIA LIFT

Ergonomic MIA chairs favour the natural movement of the body. With padded seat option for extra comfort.

Les cadires ergonòmiques MIA faciliten el moviment natural del cos. Amb opció d'encoixinat per a més confort.



Learning in motion.



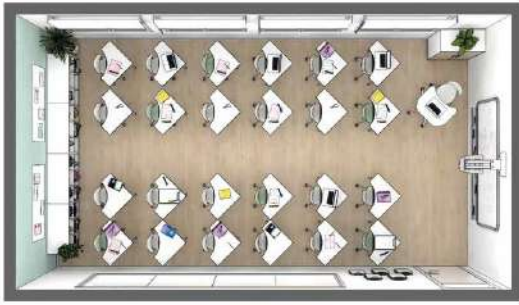

The learning experience needs guidance, but also freedom. Freedom of movement to create and dismantle work groups with versatile tables. Spaces bringing about learning with order and good acoustics to facilitate communication and comfort.

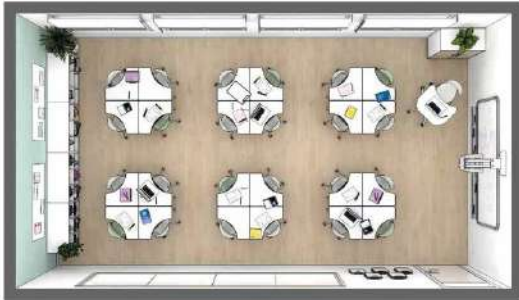

L'experiència de l'aprenentatge necessita guia, però també llibertat. Llibertat de moviment per a agrupar-se i desagrupar-se per equips de treball amb taules versàtils. Espais catalitzadors del coneixement amb ordre i bona acústica per facilitar la comunicació, la comoditat i el confort.



45 m²



24





The MINI LILY individual whiteboard and its storage system promote order and debate in the classroom.

La pissarra individual MINI LILY i el seu sistema d'emmagatzematge faciliten el debat i l'ordre a l'aula.

MINI LILY



The MOON table, adjustable in height, provides teachers with the position within the group that they need at all times.

La taula MOON, regulable en alçada, proporciona als professors la posició que necessiten en cada moment dins del grup.

MOON







*Small changes,
big improvements.*

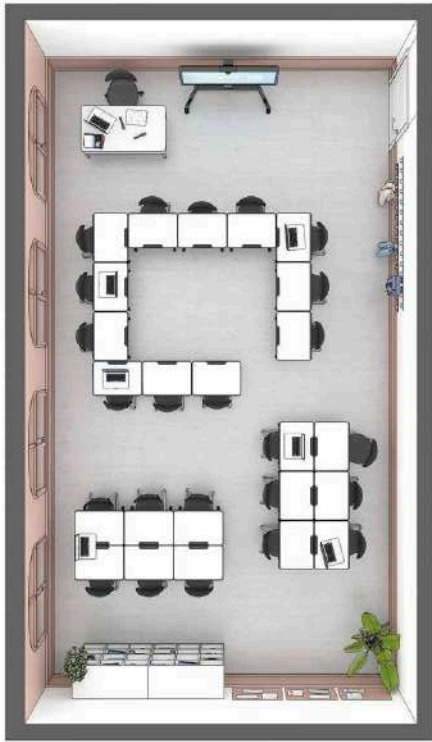

Sometimes, it all comes down to having the ideal chairs and desks to improve concentration, order and comfort, and just letting space and natural light do the rest.

De vegades només cal comptar amb els pupitres i cadires idonis per guanyar en concentració, ordre i confort i deixar que l'espai i la llum natural facin la resta.



45 m²



24

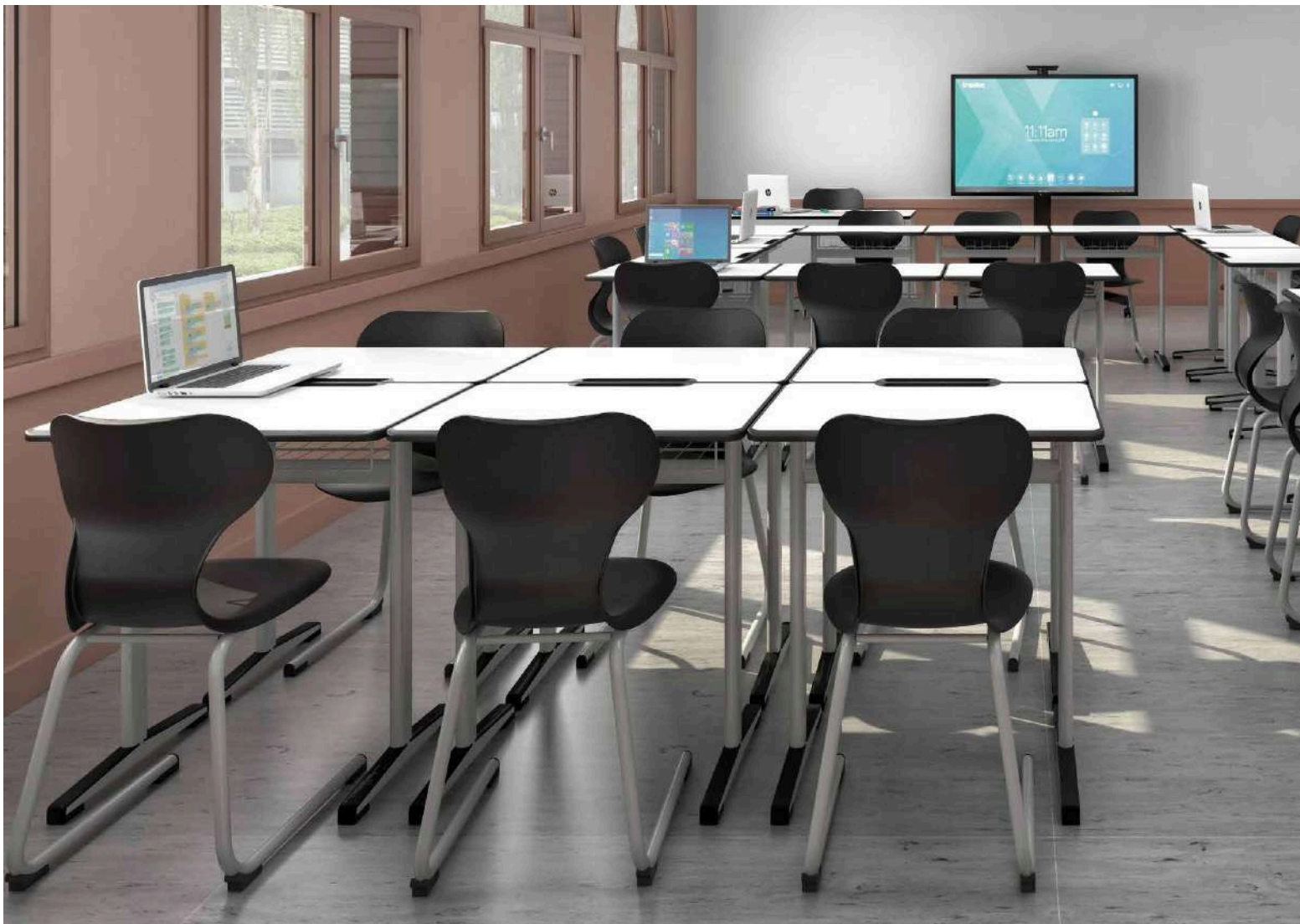



RECTANGLE TEACHER

The classical teacher's desk with drawer and modesty panel is called RECTANGLE TEACHER.

La clàssica taula per al professorat amb calaix i panell de cortesia es diu RECTANGLE TEACHER.



MIA CANTILEVER

The MIA CANTILEVER chair helps to optimize cleanliness and order in classrooms.

La cadira MIA CANTILEVER ajuda a optimitzar la neteja i l'ordre a les aules.

*Welcome to the
superclassroom.*







In multi-purpose spaces with multiple dynamics, the Teaching-how-to-Learn paradigm shift shines. In these areas, the organization of space, time and materials is key to facilitating synergies.

En els espais polivalents de múltiples dinàmiques és on brilla el canvi de paradigma de Ensenyar a Aprendre. En ells, l'organització de l'espai, temps i materials és clau per a facilitar sinergies.



150 m²



60





MIA TABLE

MIA TABLE chairs with folding table and lower storage tray to easily form and dismantle groups.

Cadires amb pala i emmagatzematge MIA TABLE per formar i desfer grups fàcilment.



MIA STORE

Large work tables and MIA STORE chairs with a storage tray so that dynamism in the super classroom does not mean clutter.

Àmplies taules de treball i cadires MIA STORE amb safata d'emmagatzematge per tal que el dinamisme a la súperaula no n'alteri l'ordre.



Marga Tubau

Sales Manager

What can make neurons dance?

A strategically placed sofa. A panel that turns into a mobile whiteboard. Let the desire to learn, share ideas and contrast them find their space in any corner.

Què pot fer que les neurones ballin?

Un sofà estratègicament ubicat. Un panell que és una pissarra mòbil. Fem que les ganes d'aprendre, compartir idees i contrastar-les trobin espai a qualsevol racó.

Tips for corners



A passage area or a corner of 3m² allows a one-on-one meeting.

Una zona de pas o un racó de 3m² donen lloc a una reunió de tu a tu.

The combination of grades in different sizes creates a facilitating space for meetings and discussions.

La combinació de grades de diferents dimensions crea l'espai facilitador per al fòrum o el debat.



Create a discussion area in a classroom: it just takes a sofa, a whiteboard and an acoustic divider.

Crear una zona de debat en una aula: la classroom dins de la classroom només necessita un sofà, una pissarra i un divisor acústic.

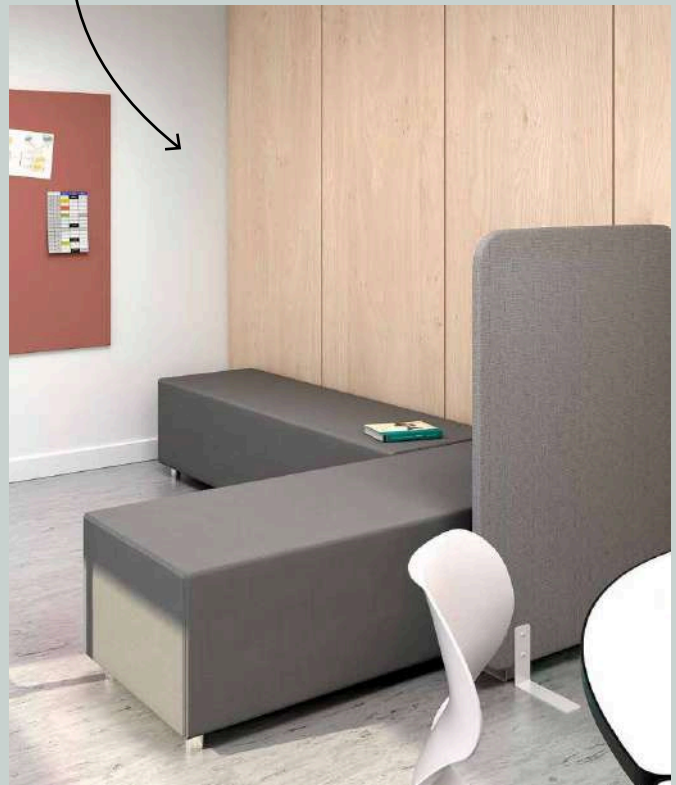



S.T.E.A.M.

Classrooms with space for everything

The desire to learn is the engine for knowledge and an endless source of personal satisfaction. Stimulating spaces have to be created.

A classroom where the teacher can play different roles and students can perform different activities at the same time?

Les ganes de saber són el motor del coneixement i una inesgotable font de satisfacció personal. S'han de crear espais que les estimulin.

Una aula on el docent pot exercir diferents rols i els alumnes desenvolupar diferents activitats a la vegada?

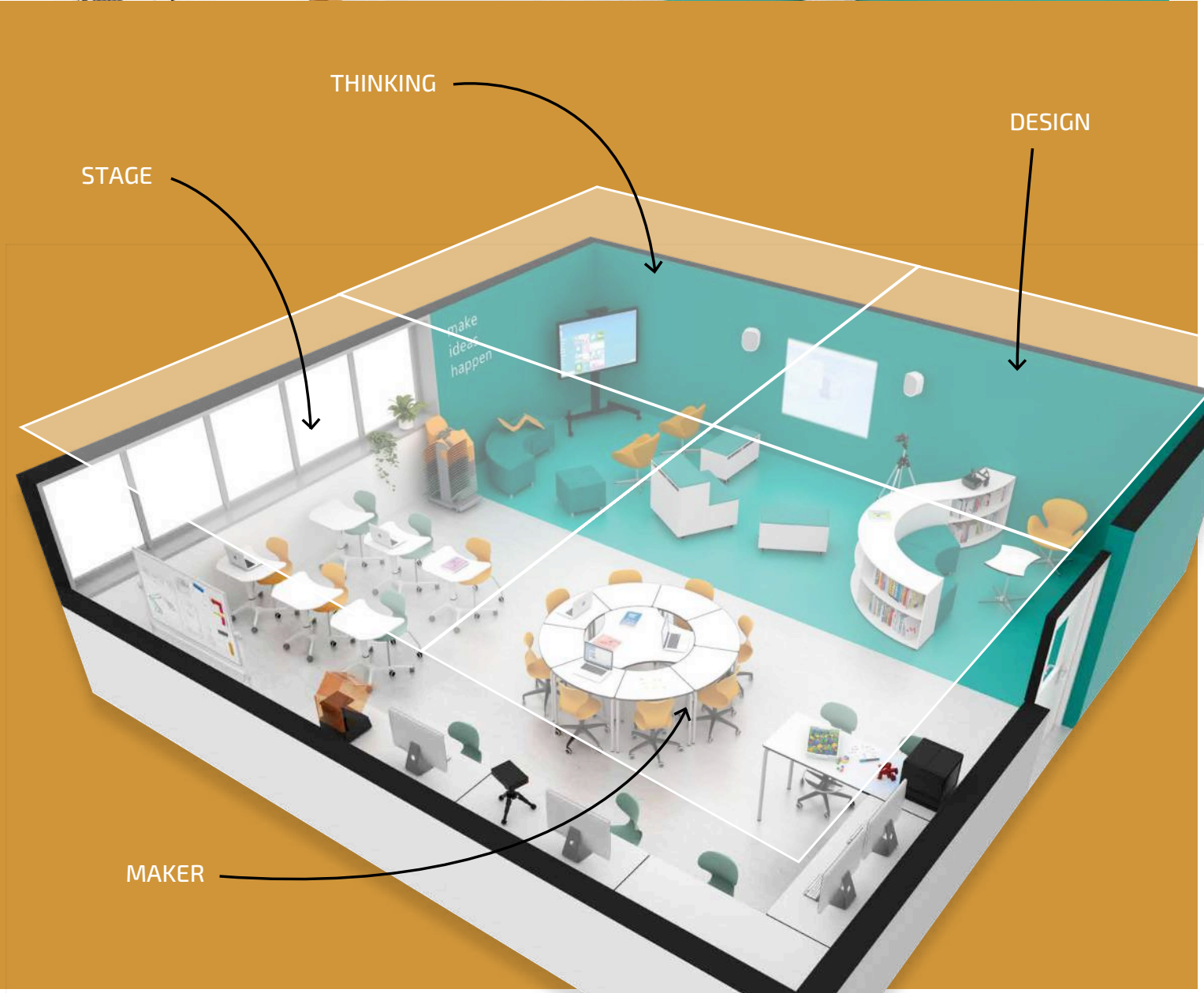

The same stage multiple spaces





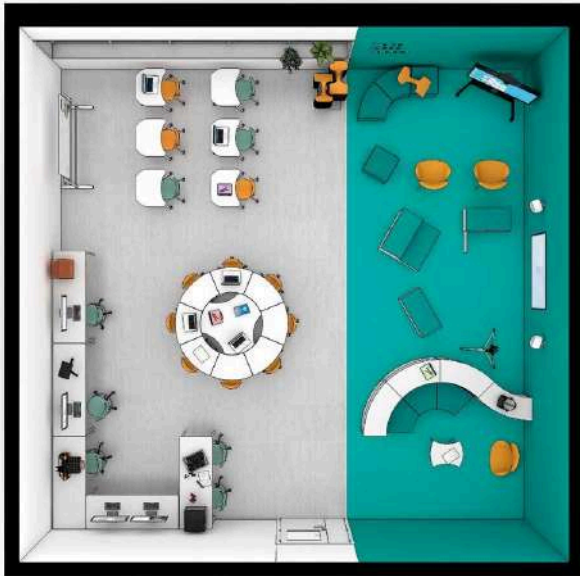

A multidirectional space with zones to carry out different activities related to the same project not only optimizes time and space, but it also fosters concentration and cooperative work.

The goal is to create spaces that are allied with knowledge. Shall we do it?

Un espai multidireccional amb diferents zones per a diverses activitats relacionades amb l'execució d'un mateix projecte no només optimitza temps i espai, també estimula la concentració i el treball cooperatiu.

L'objectiu és crear ambients que s'aliïn amb el coneixement. Som-hi?



87 m²



40





MOVE

MINI MOVE

MOVE and MINI MOVE grades create a forum area for exhibitions and debates.

Les grades MOVE i MINI MOVE creen una zona fòrum per a l'exposició i el debat.



OCTA

TRISIX

OCTA and TRISIX tables allow you to quickly create work groups, providing a design zone when needed.

Les taules OCTA i TRISIX permeten crear àgilment grups de treball tot facilitant una zona design quan es necessita.



Ideas lab.





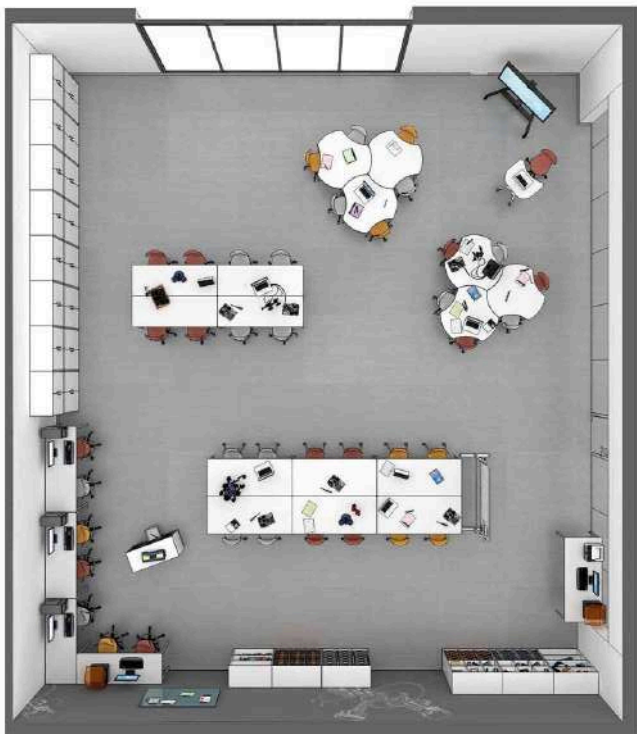

Design contributes to making the educational experience more effective, pleasant and fulfilling in the technology classroom.

Freedom of movement is key here for an agile manipulation of the object of study and the possibility of grouping in small work teams. Whiteboards and mobile auxiliary furniture allow the sharing of ideas and materials

El disseny contribueix a fer l'experiència educativa més eficaç, agradable i plena a l'aula tecnològica.

Aquí, la llibertat de moviment per a una àgil manipulació de l'objecte d'estudi i l'opció d'agrupar-se en equips de treball reduïts és clau. Les pissarres i els mobles auxiliars mòbils permeten compartir idees i materials.



150 m²



45



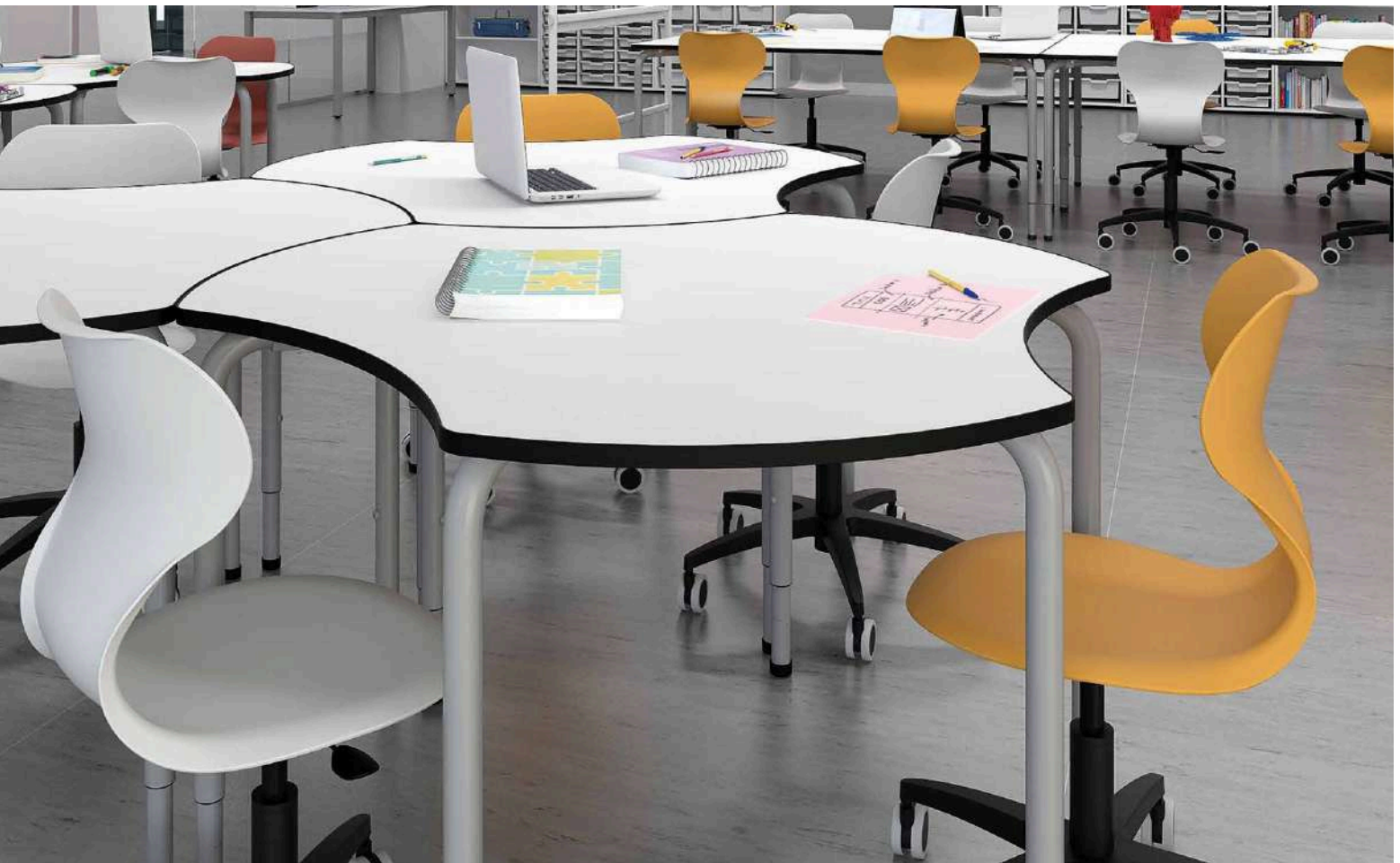

MIA STOOL

RECTANGLE PLUS

High and spacious tables, ideal for teamwork and ergonomic stools.
RECTANGLE PLUS table and MIA stools.

Taules altes i espaioses, idònies per a treballar en equip i tamborets ergonòmics.
Taula RECTANGLE i tamboret MIA STOOL.



TRISIX

Versatile and easy to fit tables to form and dismantle work teams.

Taules versàtils i fàcilment emmagatzemables per a formar i desfer grups de treball.

Teacher's space

The engine and heart of the school are the teaching team. Teachers need a space to rest, relax and at the same time work as a team, talk and continue promoting education today and tomorrow.

How do you imagine the staff room?

El motor i cor de l'escola és l'equip docent. El professorat necessita un espai per a descansar, relaxar-se i a la vegada treballar en equip, conversar i seguir impulsant l'educació d'avui i de demà.

Com imagines la sala de professors?

TEACHER'S SPACE

Creators of learning experiences

If the teacher is the designer of the learning experience, the educational space is the setting that inspires it.

Si el docent és el dissenyador de l'experiència d'aprenentatge, l'espai educatiu és l'escenari que l'inspira.





A small oasis.

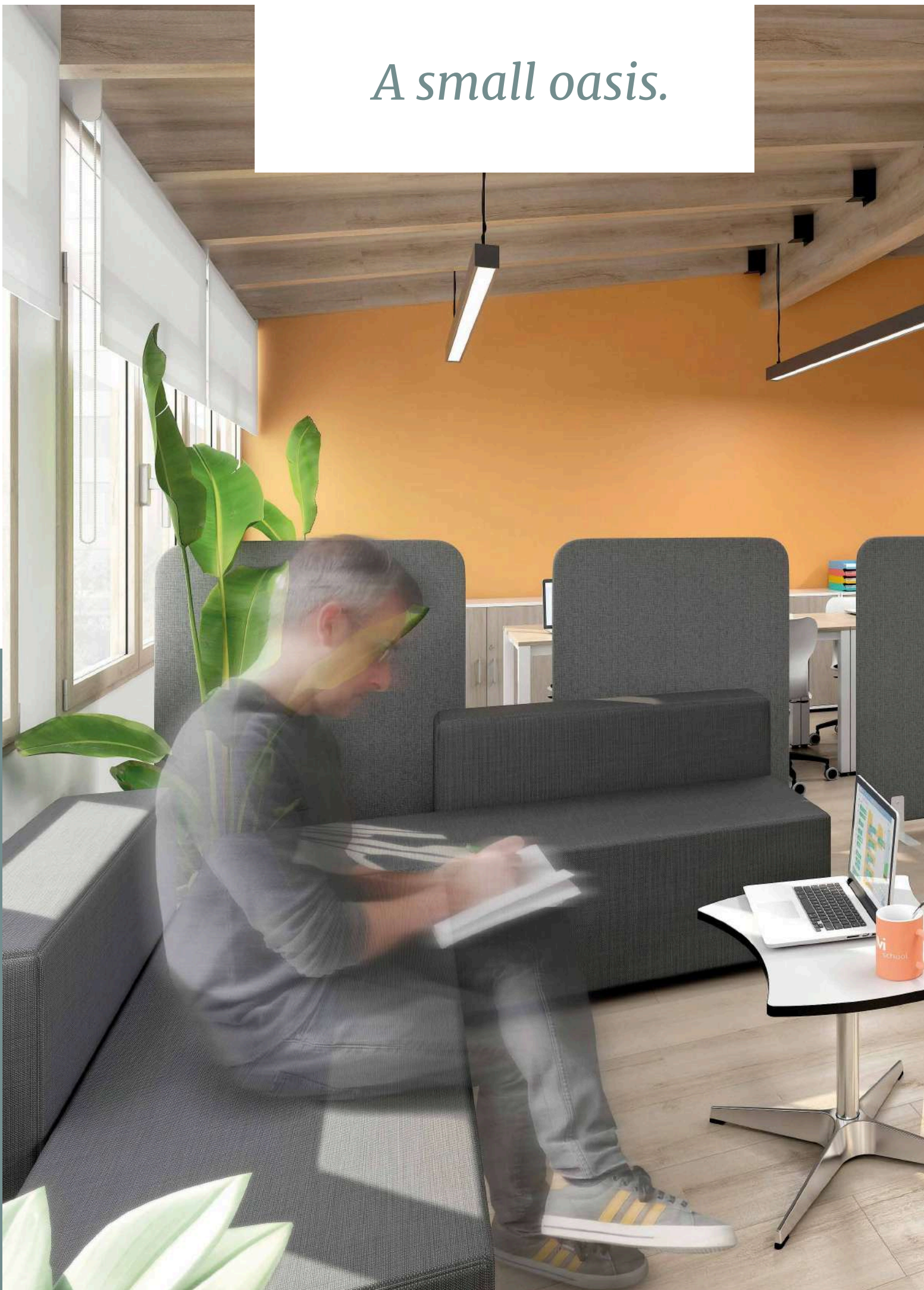





The place for reflection, assessment, content preparation and rest. The space for interaction between co-workers and meetings between tutors and students.

El lloc per a la reflexió, l'avaluació, la preparació de continguts i el descans. L'espai per a la interacció entre companys de treball i les reunions entre tutors i alumne.



50 m²



22





SAMOS

SAMOS dividers separate and isolate acoustically.

Els divisors SAMOS separen i aïllen acústicament.

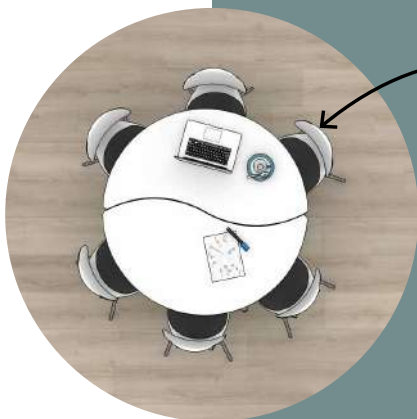

YANG

YANG tables to close the circle.

Taula YANG per a una taula rodona.



The background of the page is a photograph of a building facade with light-colored stone or brickwork. In the lower-left corner, the front wheel of a bicycle with a bright orange rim is visible. The text is overlaid on a dark teal rectangular area.

Multi — purpose spaces

Spaces are constantly evolving and many of them are transformed and inhabited in multiple ways. The diversity of activities gives way to the versatility, movement and multiple uses of furniture.

How to create multifunctional spaces?

Els espais estan en constant evolució i molts es transformen i habiten de múltiples formes. La diversitat d'activitats dona pas a la versatilitat, el moviment i a múltiples usos del mobiliari.

Com crear espais multifuncionals?

MULTIPURPOSESPACES

Libraries shout: Come!

Libraries go from being a place where people just do research to become a place to go to feel more productive or to be close to friends and colleagues.

They become interdisciplinary, inclusive and inspiring learning spaces.

Les biblioteques passen de ser un lloc on s'hi va només a fer recerca a un lloc que es visita per a sentir-se més productiu o estar a prop d'amics i col·legues.

Es converteixen en espais d'aprenentatge interdisciplinars, inclusius i inspiradors.





Wellness feeling.







Libraries are at the intersection of academic, social and emotional needs. They become a meeting place where students can grow in many aspects.

Les biblioteques són a l'intersecció de les necessitats acadèmiques, socials i emocionals. Es converteixen en lloc de reunió on els estudiants poden desenvolupar-se en múltiples aspectes.



220 m²



75





Areas to sit and read as you would at home. Set of armchair and low table.

CHARLOTTE

Zones per asseure's a llegir com si fossis a casa. Conjunt de butaca i taula baixa.

LOUISE



Furniture with organic shapes that allows dividing spaces and create a comfort zone with sofas.

MARIE

Mobiliari de formes orgàniques que permet delimitar espais i crear una zona de confort amb sofàs.





Joan Jalencas

Sales Manager

Get together, meet, concentrate, explain, experiment, share, listen actively, etc., in different areas within the same educational, with versatile and mobile furniture, as well equipped as the mind is when learning.

Agrupar-se, reunir-se, concentrar-se, explicar-se, experimentar, compartir, escoltar activament... en un espai educatiu amb zones diferenciades amb mobiliari versàtil i mòbil, tan ben equipades com la ment quan aprèn.

Tips for corners



The MARIE curved cabinet surrounds a space that, together with the ANGLE sofa, invites to meet in small groups to debate.

L'armari corbat MARIE envolta un espai que, amb el sofà ANGLE, convida a reunir-se en petits grups per a debatre.

The double-height MARIE curved cabinet creates an interior space that enables a quiet work area with a large table.

L'armari corbat MARIE de dues alçades crea un espai interior que habilita una zona de treball tranquil·la amb una taula espaiosa.



The CHARLOTTE armchair, with its wraparound seat, leads to internalisation, calm and meditation.

La butaca CHARLOTTE, amb seient envoltant, porta a l'interiorització, la calma i la meditació.







Canteen

Educate, socialize and rest in the canteen
to nurture students and teachers.

Each age has specific needs and creating a pleasant and
calm atmosphere around the table is the starting point.
How to create canteens that nurture learning?

Educar, socialitzar i descansar des del menjador
per a nodrir alumnes i professorat.

Cada edat té unes necessitats concretes i crear un entorn
agradable i tranquil al voltant de la taula és el punt de partida.
Com crear menjadors escolars que alimentin l'aprenentatge?

CANTEEN

Much more than eating

Eating is a basic need. So are socializing, enjoying, savouring, learning, sharing, relaxing and nourishing oneself internally and externally.

Alimentar-se és una necessitat. Socialitzar, gaudir, assaborir, aprendre, compartir, descansar i nodrir-se per dins i per fora, també.





Meeting point.







As at home, where kitchen becomes the nerve centre where life happens, we can turn the canteen into something more than just a place to eat. The wood finishes, the organic colors and the design aiming to offer comfort are the key.

Tal com passa a casa, on la cuina acaba sent el centre neuràlgic on es desenvolupa la vida, podem aconseguir que el menjador escolar serveixi per a molt més que menjar. Els acabats de fusta, els colors orgànics i el disseny, pensat per a oferir confort i comoditat, són la clau.



108 m²



48





INA

The INA chair is stackable, easy to clean and maintain.

La cadira INA és apilable, fàcil de mantenir i de netejar.



IRENE

The IRENE cabinet with its wooden doors brings warmth to the canteen and helps keep the space tidy and clean.

L'armari IRENE amb les seves portes de fusta aporta caliu al menjador i ajuda a mantenir-ne l'espai ordenat i net.

EARLY AGES

Sensory experimentation

A classroom with different corners where symbolic play can be developed and sensory stimulation favored by manipulating different objects that are the center of interest for the little ones.

Una aula amb diferents racons per al joc simbòlic i per a afavorir l'estimulació sensorial amb la manipulació de diferents objectes que són el centre d'interès dels més petits.



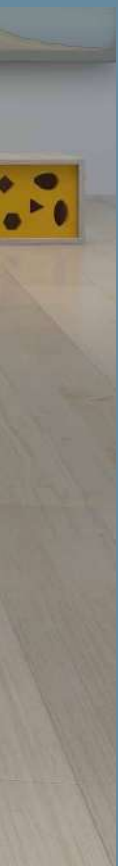

The living classroom.





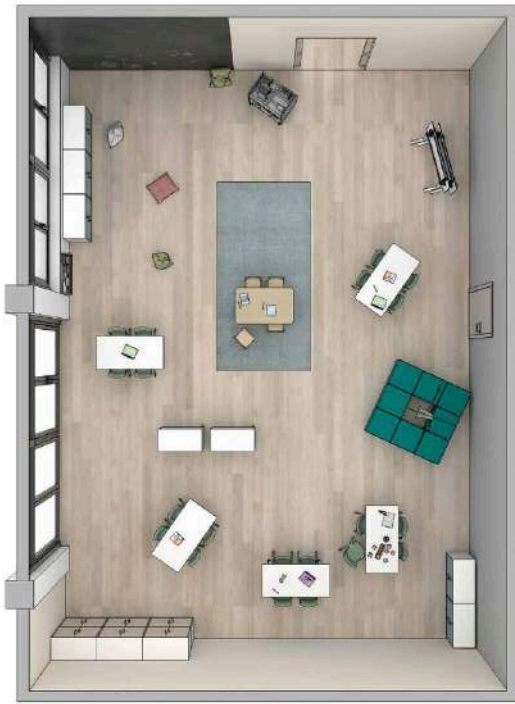

Classrooms where different educational dynamics coexist simultaneously, where the little ones move, group and ungroup to experiment, rest, play.

Aules on conviuen simultàniament diferents dinàmiques educatives, on els més petits es mouen, s'agrupen i desagrupen per a experimentar, descansar i jugar.



100 m²



25





TEO

The wood in tables (TEO) and chairs (ZOE) brings warmth and comfort to the classroom.

La fusta en taules (TEO) i cadires (ZOE) aporten caliu i confort a l'aula.

ZOE



HEDY

The HEDY cabinet on castors allows you to comfortably and dynamically separate spaces.

L'armari amb rodes HEDY permet separar espais còmodament i de forma dinàmica.

MINIFLOOP

The MINIFLOOP tables are folding and allow you to quickly transform a workspace into an open space to play or rest.

Les taules MINIFLOOP són abatibles i permeten transformar ràpidament un espai de treball en un de diàfan per a jugar o descansar.



*Montessori-inspired
classroom.*





A modular classroom in which cooperative work is the core and the child the protagonist of their experience and learning. With tables that allow various configurations to expand the multiple intelligences.

Una aula modular on el treball cooperatiu és l'eix i el nen el protagonista de la seva experiència i aprenentatge. Amb taules que permeten diferents configuracions per a expandir les múltiples intel·ligències.



40 m²



25





MIA MINILIFT

The MIA MINILIFT chair for adults adapts to the height of children's tables for greater comfort for teachers and students.

La cadira MIA MINILIFT per a adult s'adapta a l'alçada de les taules infantils per a un millor confort de docents i alumnes.

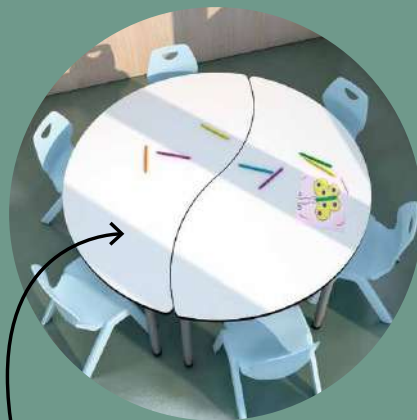

MIA MINILIFT

The YANG table allows you to quickly create round tables and also different configurations.

La taula YANG permet crear taules rodones i altres configuracions fàcilment.



*The importance
of order.*





Storage in the classroom favors both spatial and mental order. Tables and cabinets that, with their design, colour and resistance to shocks and water, favor visual and experiential harmony in the classroom.

L'emmagatzematge a l'aula afavoreix l'ordre, tant el de l'espai com el mental. Taules i armaris que, amb el seu disseny, cromatisme i resistència als cops i a l'aigua, promouen l'harmonia visual i experiencial a l'aula.



60 m²



25





GRACE

The GRACE cabinet with trays in two sizes, guided by rails to prevent them from coming out of the cabinet.

L'armari GRACE amb safates de dues mides, guiades per rails per evitar que s'en surtin.



RONY

The RONY table has adjustable legs at different heights for the comfort of all.

La taula RONY té les potes ajustables a diferents alçades per a comoditat de tots.

Furnishing spaces that furnish minds

This is our passion. We understand how students learn and how educators in the 21st century want to teach. As education keeps evolving, so do we.

És la nostra passió. Entenem com aprenen els estudiants i com volen ensenyar els docents del segle XXI. A mesura que l'educació segueix evolucionant, nosaltres també.

Chairs

Reconcile with the movement.
Chairs that facilitate grouping and ungrouping quickly and without noise, that promote order and prioritize dynamic comfort. Chairs not only designed for sitting down.

Reconciliar-se amb el moviment.
Cadires que faciliten agrupar-se i desagrupar-se àgilment i sense sorolls, que afavoreixen l'ordre i prioritzen un confort dinàmic. Cadires no només pensades per al moment de seure.





JON



60% Recycled Plastic



SIZE

(+infoP. 193)

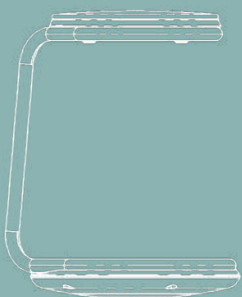

53,5 CM

DETAILS

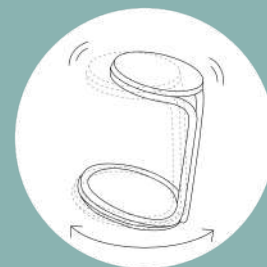

JON







MIA



60% Recycled Plastic

MIA BASIC



MIA CANTILEVER



MIA CASTORS



MIA MINI LIFT



MIA LIFT



MIA BIG LIFT



MIA STOOL



MIA STORE



MIA TABLE





MIA BASIC



SIZE (+infoP. 193)



OPTIONS



DETAILS



MIA CANTILEVER



SIZE (+infoP. 193)

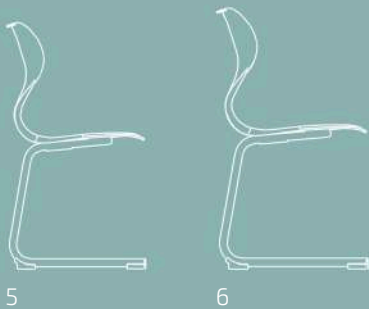

OPTIONS



DETAILS





MIA CASTORS



SIZE

(+infoP. 193)



4



5



6

OPTIONS



DETAILS



MIA MINI LIFT



OPTION Ref. 0129

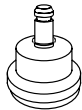

SIZE

(+infoP. 193)



31-39,5 CM

DETAILS





MIA LIFT



OPTION Ref. 0129

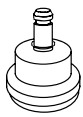

SIZE

(+infoP. 193)

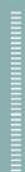

40-51 CM

OPTIONS



DETAILS



MIA BIG LIFT



OPTION Ref. 0129

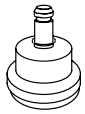

SIZE (+infoP. 193)



40-51 CM

OPTIONS



DETAILS





MIA STOOL



OPTION Ref. 0129

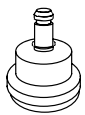

SIZE (+infoP. 193)

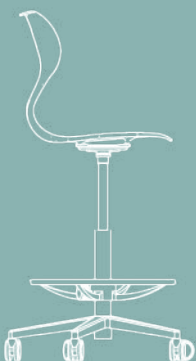

58-83 CM

OPTIONS



DETAILS



MIA STORE



SIZE
(+infoP. 193)

OPTIONS

DETAILS





MIA TABLE



SIZE

(+infoP. 193)



57X33 CM

OPTIONS



DETAILS





360°





ZTOOL



60% Recycled Plastic



36X25 CM



ZTOOL TROLLEY



X 40 ZTOOL





SIZE
(+infoP. 193)

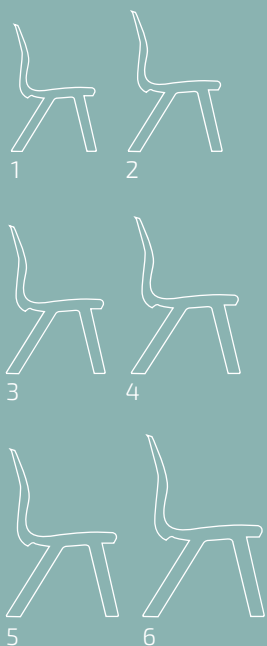

INA_{Ref. 147}



Global Recycled Standard
60% Recycled Plastic

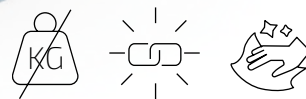

SIZE
(+infoP. 193)

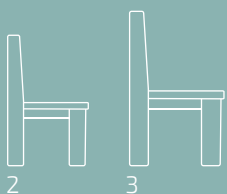

ZOE



DETAILS | DETALLES







Soft seating

Socialize, share and relax.
Soft seating furniture allows you to create a space for impromptu conversations and allows you to bring life to areas of the educational centre that have not been used until now.

Socialitzar, compartir i relaxar-se.
El mobiliari soft seating permet crear un espai per a converses improvisades i permet donar vida a zones del centre educatiu fins ara desaprofitades.







CHLOE



SIZE

69 CM

67 CM



79 CM



44 CM

DETAILS



CHARLOTTE

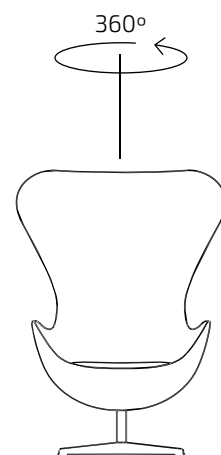

SIZE

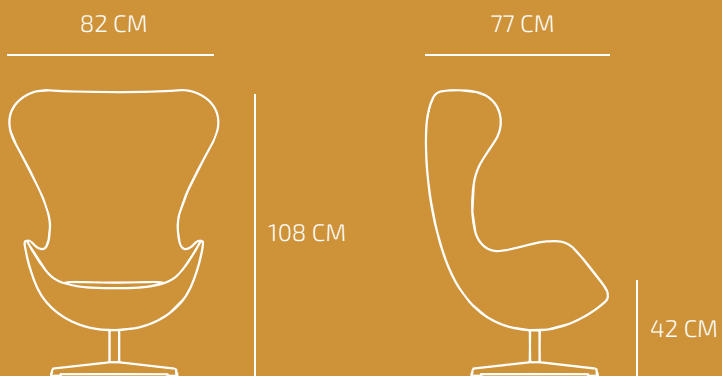

DETAILS





ANGLE

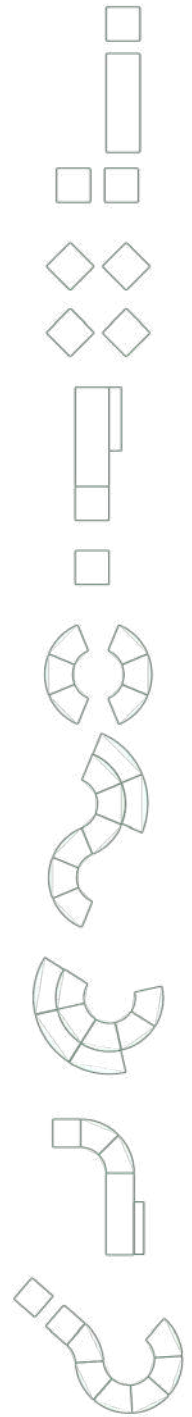

CUBE

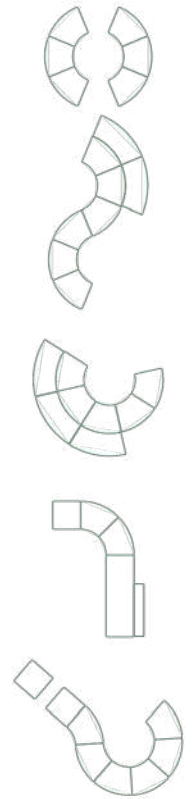

SIZE

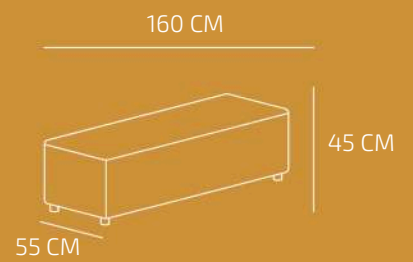
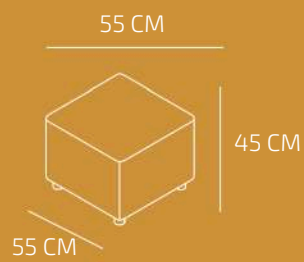
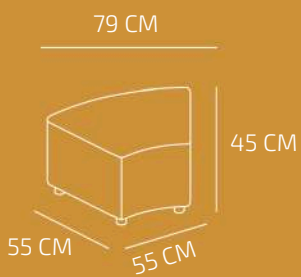



TUBE

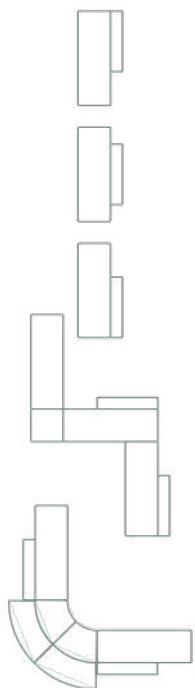
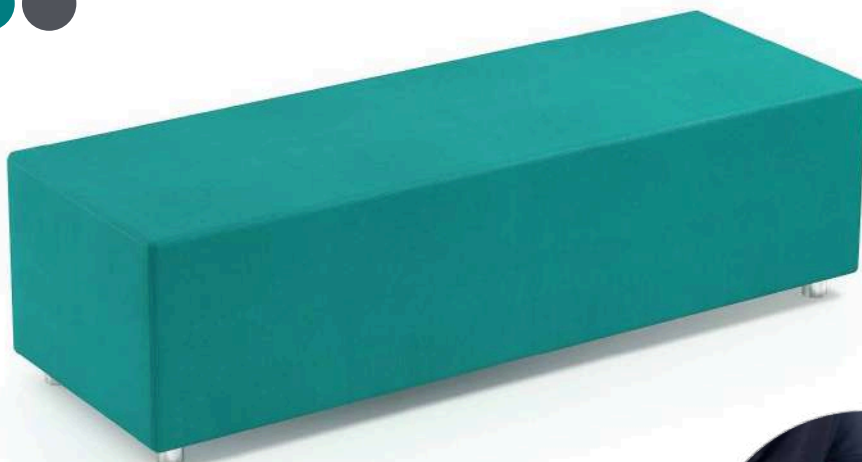

COMPLETE SOFA

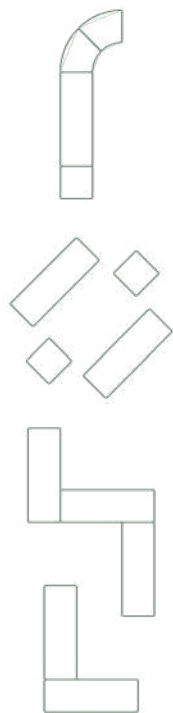

SIZE

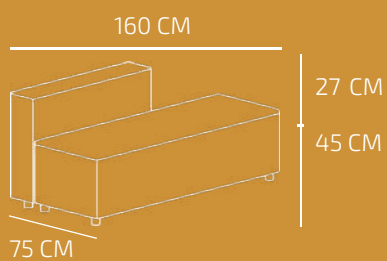

DETAILS





MOVE



Easy to move



SIZE

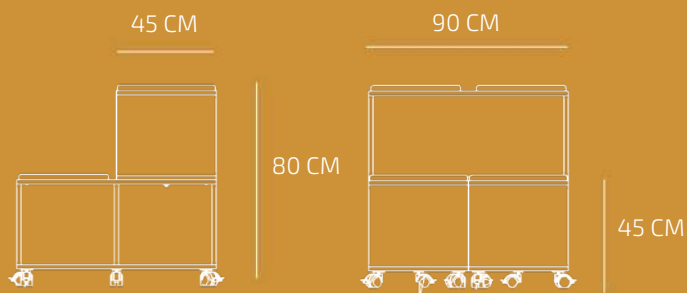

DETAILS



MINI MOVE



Easy to move



SIZE

45 CM

90 CM

45 CM

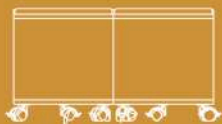

DETAILS



Tables

Work platforms. Tables that allow classrooms to be quickly configured and adapted for collaborative work. With height-adjustable, mobile, easy to fit and storable designs to quickly facilitate the execution of any task.

Plataformes de treball.

Taules que permeten configurar i adaptar les aules àgilment per al treball col·laboratiu. Amb dissenys ajustables en alçada, mòbils, encaixables i emmagatzemables per facilitar ràpidament l'execució de qualsevol tasca.

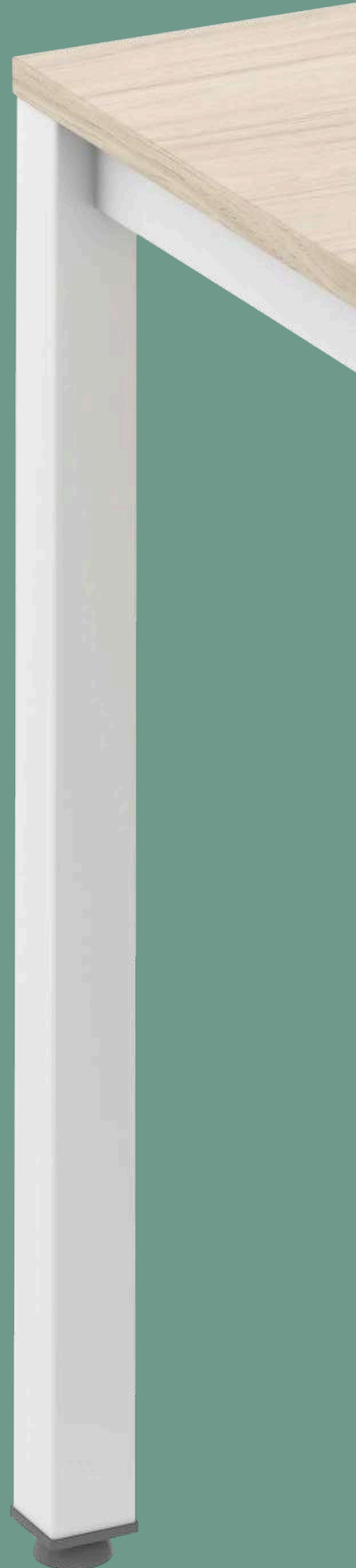



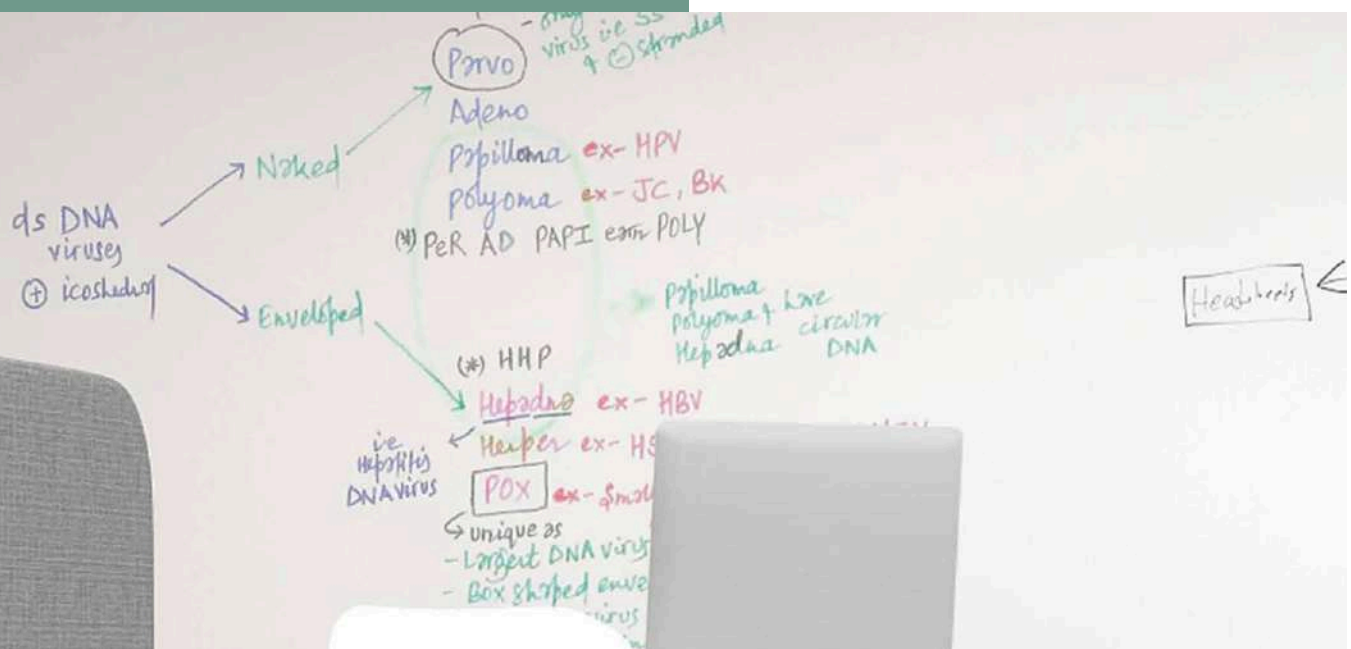

MOON



MAX.
H 102 cm



MIN.
H 73 cm



SIZE

(+infoP. 193)

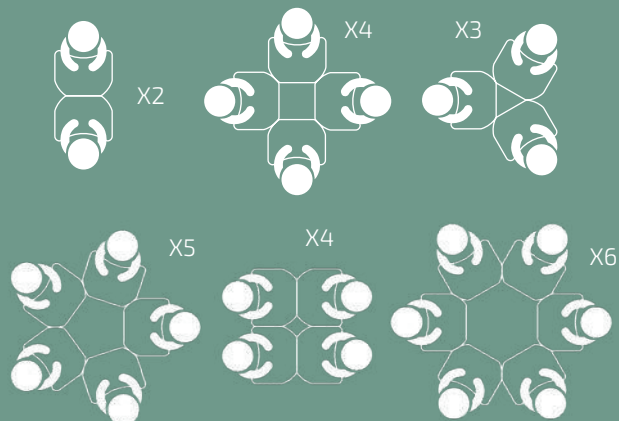

DETAILS





SQUARE



Injected PP edge



OPTIONAL



SIZE

(+infoP. 193)

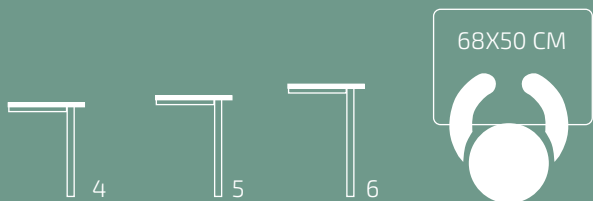

DISTRIBUTION

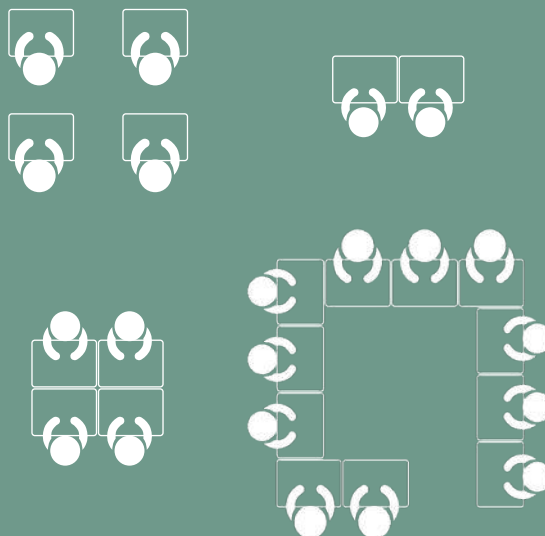

COMBINATIONS

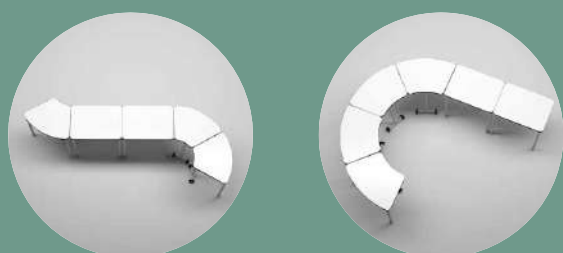

ARROW

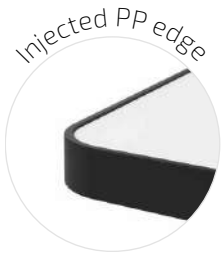

SIZE (+infoP. 193)

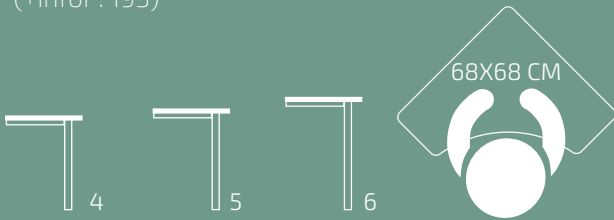

COMBINATIONS

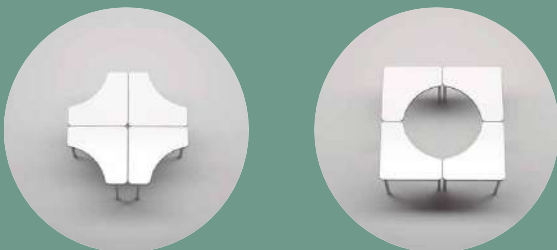

DISTRIBUTION

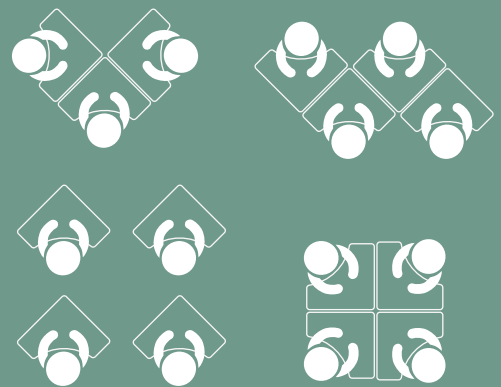



HEXA



SIZE

(+infoP. 193)

72X50 CM



4



5



6



COMBINATIONS

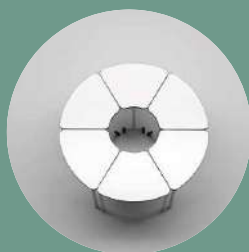

DISTRIBUTION



Ø 150 cm



OCTA



SIZE (+infoP. 193)

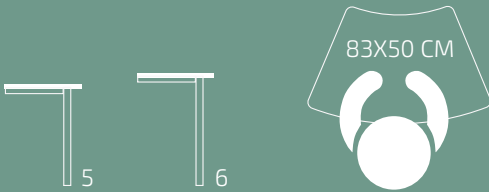

COMBINATIONS

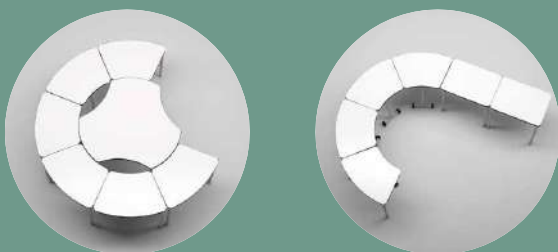

DISTRIBUTION

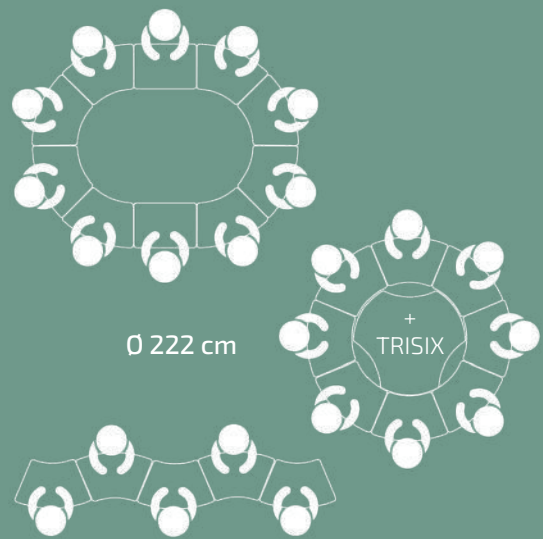



YANG

Ref. 2345RC (1-3)
Ref. 2345R (4-6)



1-3



4-6

ABS edge



OPTIONAL



SIZE

(+infoP. 193)



DISTRIBUTION

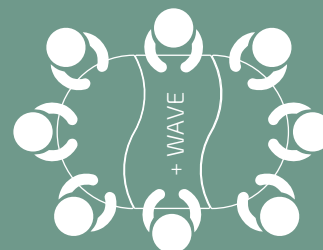

WAVE

Ref. 2344RC (1-3)
Ref. 2344R (4-6)



1-3



4-6

ABS edge



OPTIONAL



SIZE

(+infoP. 193)



130X65 CM

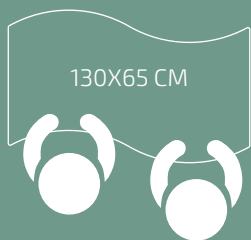

DISTRIBUTION

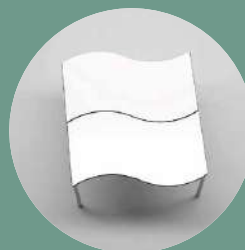
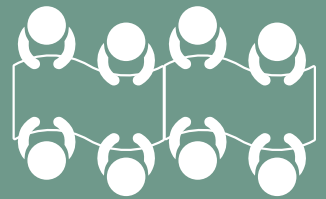
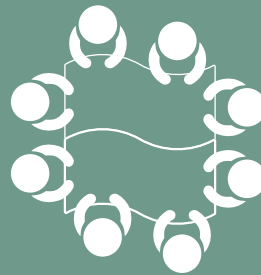



TRISIX

Ref. 2346RCIN(1-3)
Ref. 2346IN(4-6)



1-3



4-6

Injected PP edge



OPTIONAL



SIZE

(+infoP. 193)



DISTRIBUTION

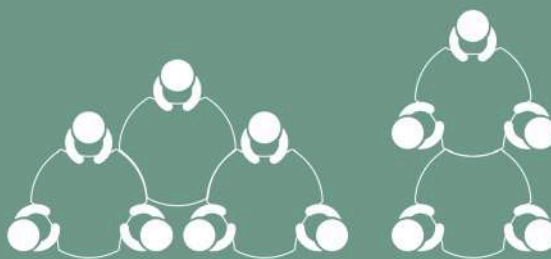

120X115 CM







RECTANGLE

Ref. 2352-3 (1-3)
Ref. 2352-6 (4-6)



1-3



4-6

ABS edge



OPTIONAL



SIZE

(+infoP. 193)



180X65 CM



120X65 CM

SIZE

(+infoP. 189)



70X80 CM

120X80 CM

140X80 CM



160X80 CM



180X80 CM

RECTANGLE PLUS

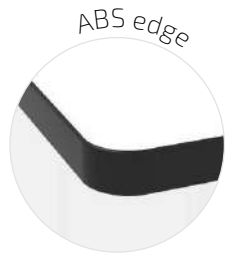

SIZE
(+infoP. 193)

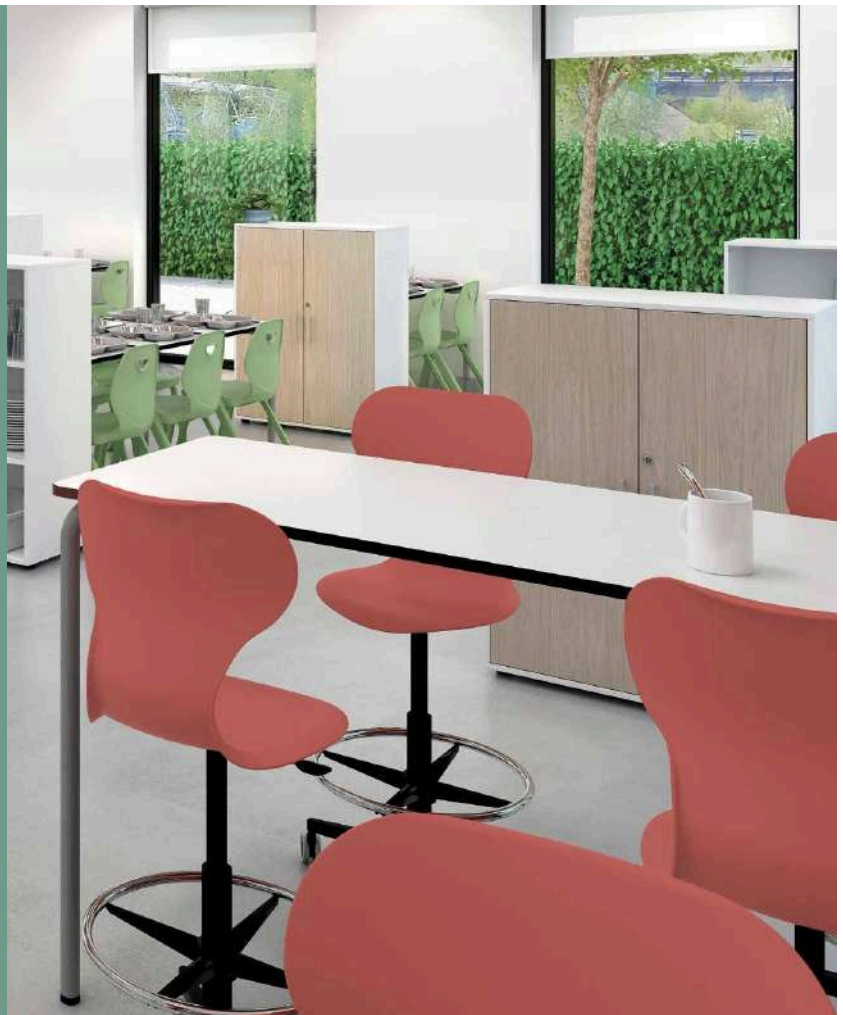





RECTANGLE TEACHER



SIZE
(+infoP. 193)



120X65 CM





NAXEL

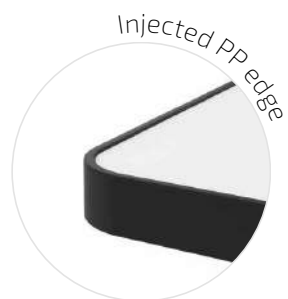

SIZE
(+infoP. 193)







QUAR ADJUSTABLE

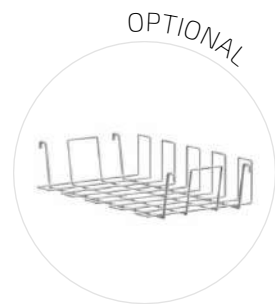

H 58-82 CM



SIZE

(+infoP. 193)

70X55 CM



DETAILS



QUAR DOUBLE ADJUSTABLE

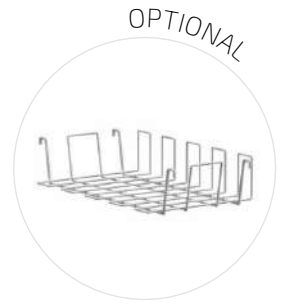

H 58-82 CM



SIZE

(+infoP. 193)

130X55 CM



DETAILS





SPACE DESIGN



OPTIONS



SIZE

(+infoP. 193)

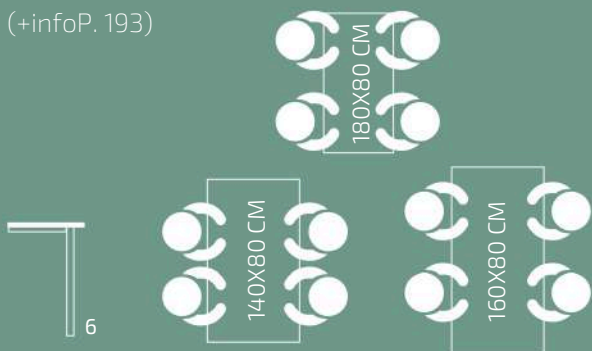

DETAILS



OPTIONS





SPACE PLUS

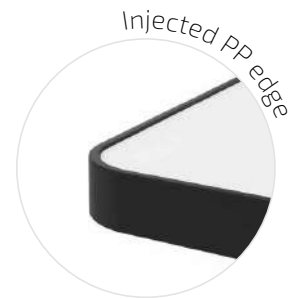

SIZE
(+infoP. 193)



DETAILS







ALUFLOOP

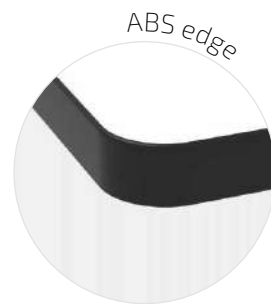

SIZE

(+infoP. 193)

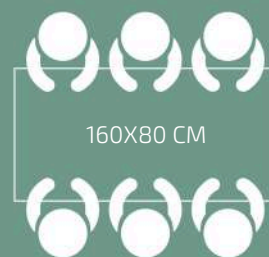
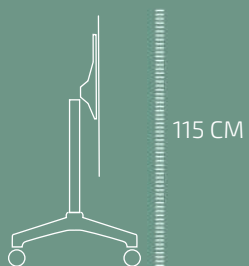

MINIFLOOP

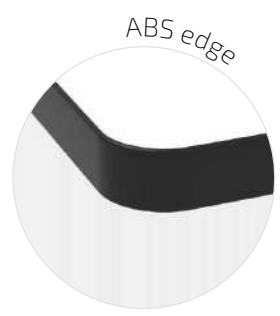

SIZE (+infoP. 193)

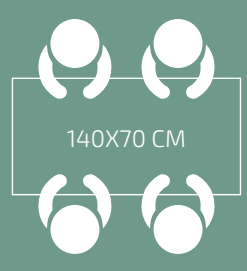
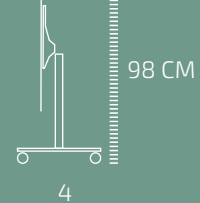
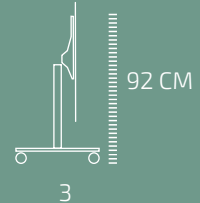
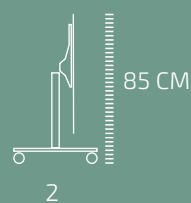
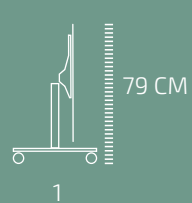



LOUISE



H 47 CM



H 70 CM



360°

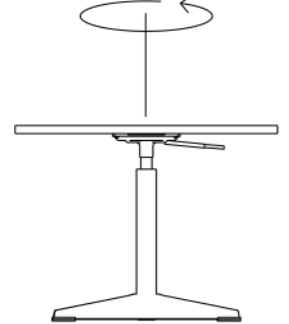

SIZE

(+infoP. 193)

66 CM

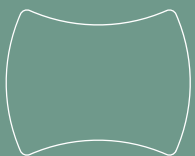

52 CM

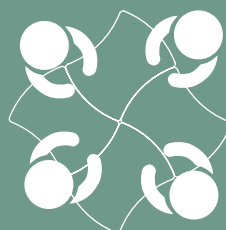

DETAILS





RONY

Ref. 2221 - 2220



SIZE

(+infoP. 193)



OPTIONS

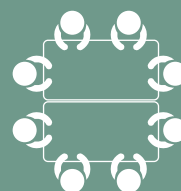
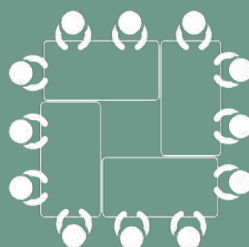
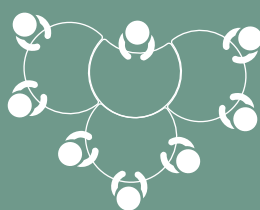









TEO



SIZE
(+infoP. 193)



DETAILS



Acoustic

Making the classroom experience better. Acoustic panels and dividers absorb sound, reduce reverberation and improve intelligibility, well-being, concentration and speech performance in classrooms.

Millorar l'experiència a l'aula. Els panells i separadors acústics absorbeixen el so, redueixen la reverberació i milloren la intel·ligibilitat, el benestar, la concentració i el rendiment de la parla a les aules."





VELVET CR

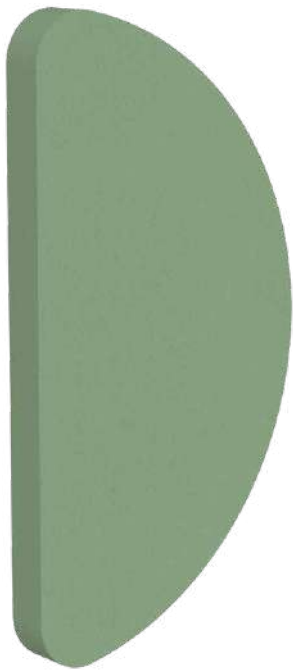

SIZE

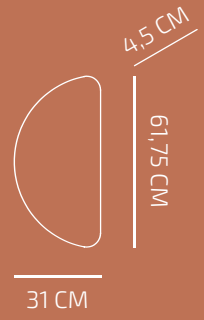

DETAILS



VELVET RF

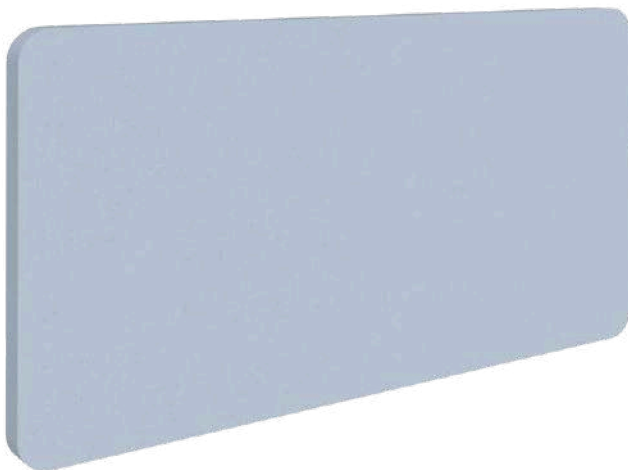

SIZE

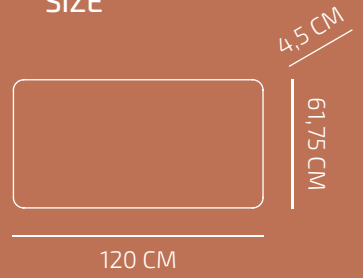

DETAILS





SIZE

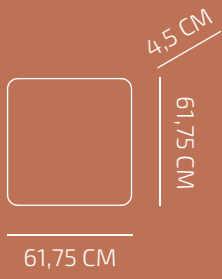

DETAILS



VELVET SQ



SIZE

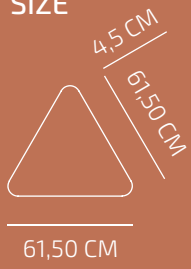

DETAILS



VELVET TR

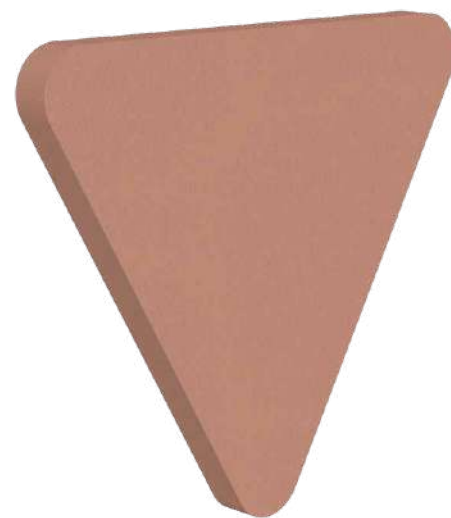



SAMOS

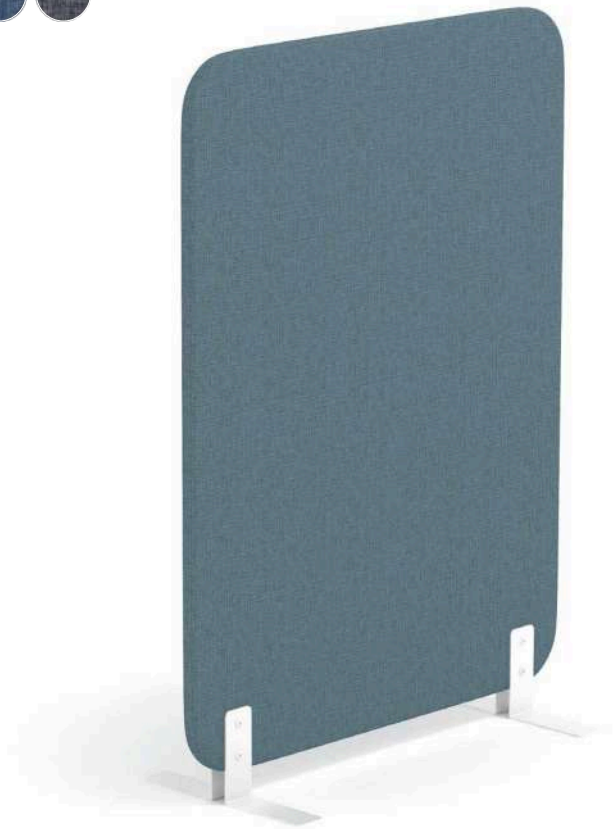

SIZE

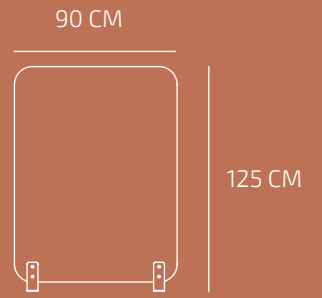

ELEA



SIZE

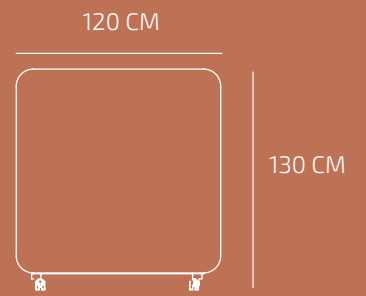



Cabinets

Everything in its place.

Each educational space and classroom have their specific requirements for learning material and distribution. Cabinets are a key element designed to facilitate the different dynamics and the order that each classroom needs.

Tot al seu lloc.

Cada espai educatiu i aula tenen requeriments específics de material d'aprenentatge i distribució. Els armaris són un element clau dissenyat per facilitar les diferents dinàmiques i l'ordre que cada aula necessita.







H 80cm



MARIE
Ref. 732-601



HEDY
Ref. 532-501



ADA
Ref. 532-502



JANE
Ref. 632-504

H 120cm



IRENE
Ref. 533-501



EMMY
Ref. 533-502



ANNIE
Ref. 633-507



SOPHIE
Ref. 633-501

H 160cm



MILEVA
Ref. 534-501



FLORA
Ref. 534-508



INGE
Ref. 534-509



ELSA
Ref. 634-508

H 200cm



EMILIE
Ref. 535-501



MAUD
Ref. 535-508



ROSIE
Ref. 535-521



MERIT

Ref. 632-507



GRACE

Ref. 632-501



ALICE

Ref. 634-510



DAN

Ref. 551

COLOURS



DETAILS



OPTIONS





MARIE



SIZE

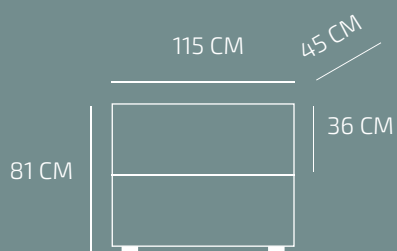

OPTIONS



COMBINATIONS





HEDY



ADA



SIZE

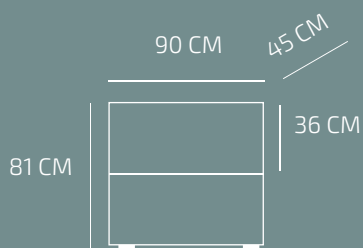

OPTIONS



DETAILS



JANE



SIZE

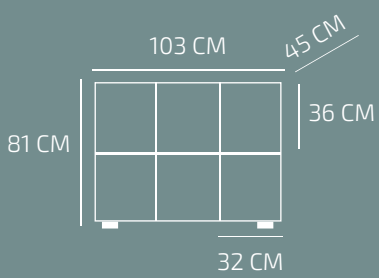

OPTIONS



MERIT

Ref. 632-507

Ref. 632-508



 x 9



 x 9



SIZE

Ref. 632-507

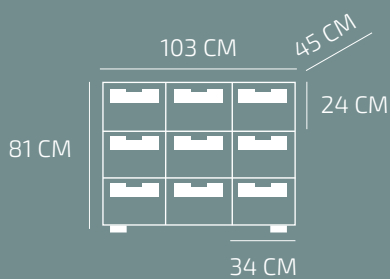

Ref. 632-508

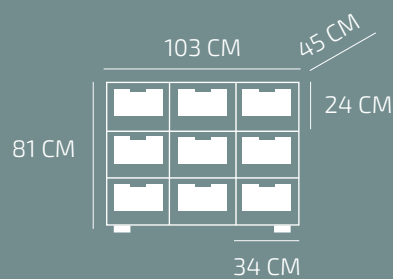

OPTIONS





GRACE

Ref. 632-501

Ref. 632-503



 x 21



 x 12



SIZE

Ref. 632-501

Ref. 632-503

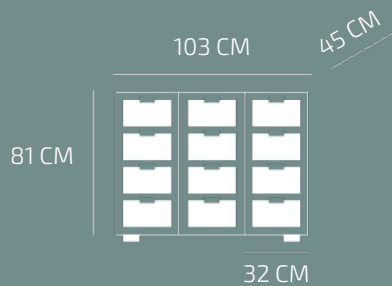
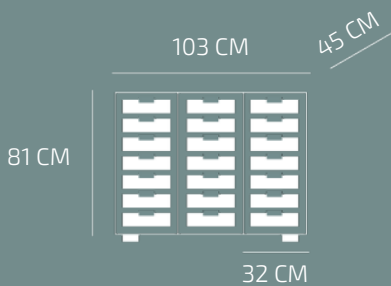

OPTIONS









IRENE



EMMY



SIZE

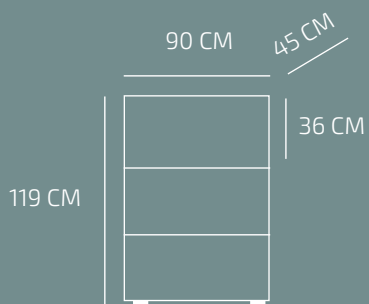

OPTIONS



DETAILS





ANNIE

Ref. 633-507

Ref. 633-509



x15



x15



SIZE

Ref. 633-507

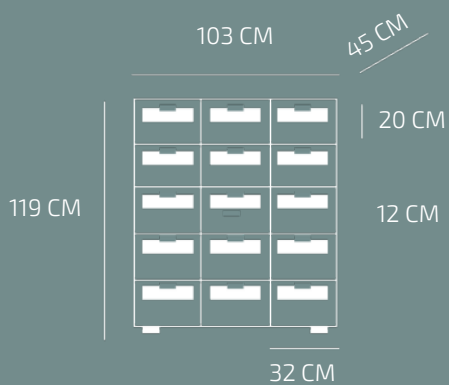

Ref. 633-509

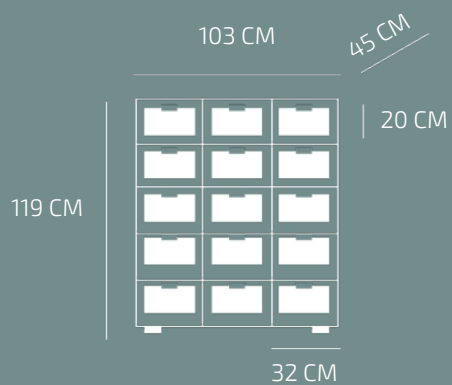



SOPHIE

Ref. 633-501

Ref. 633-503



x33



x18



SIZE

Ref. 633-501

Ref. 633-503

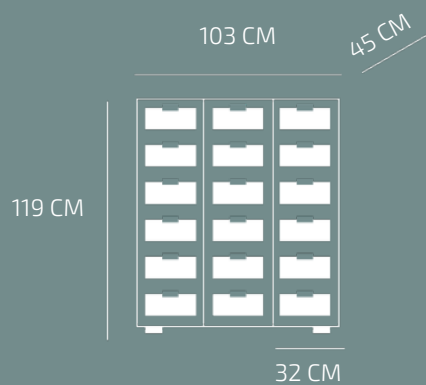
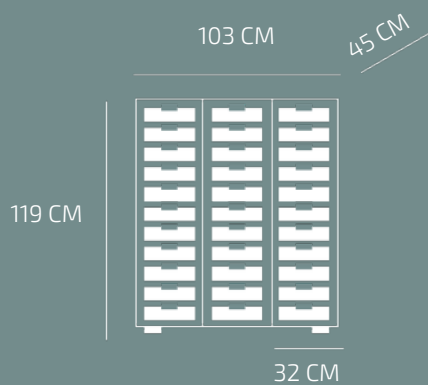

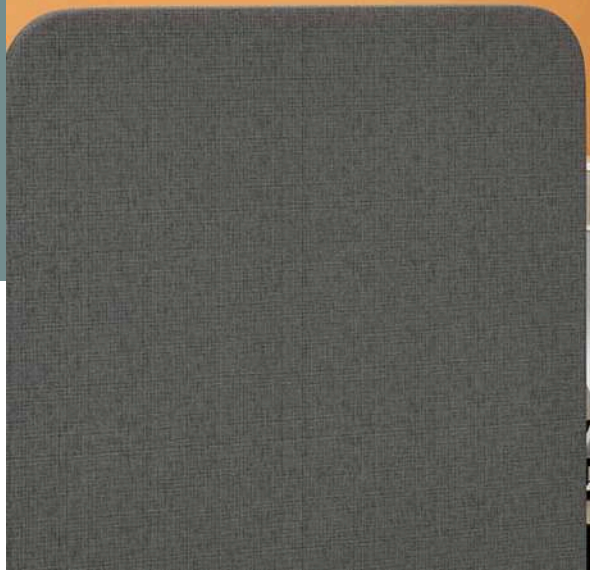

MILEVA



FLORA





INGE



SIZE

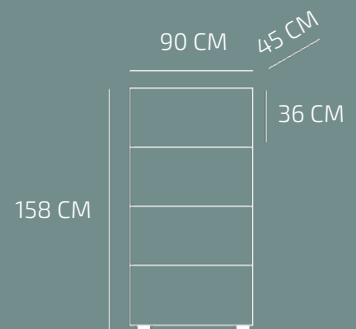

OPTIONS





ELSA



SIZE

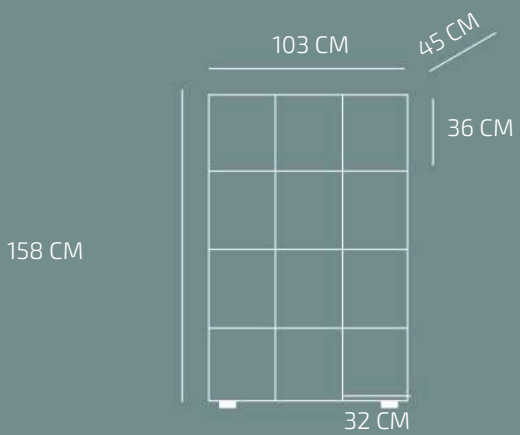

ALICE

Ref. 634-510

Ref. 634-512



 x 21



 x 12



SIZE

Ref. 634-510

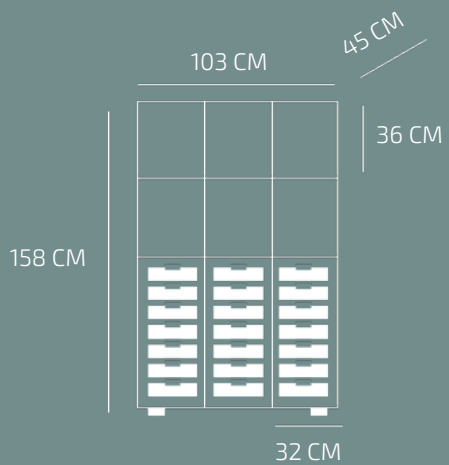

Ref. 634-512

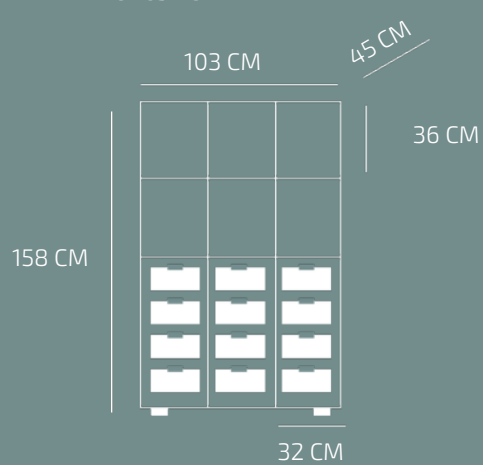



EMILIE



MAUD





ROSIE

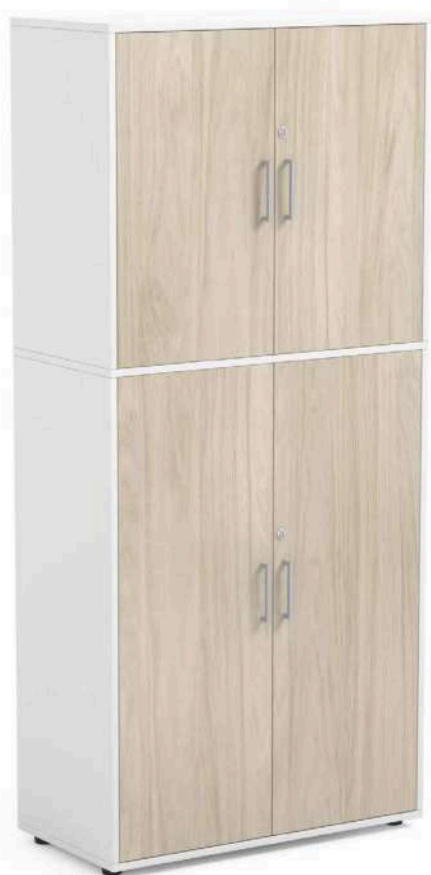

SIZE

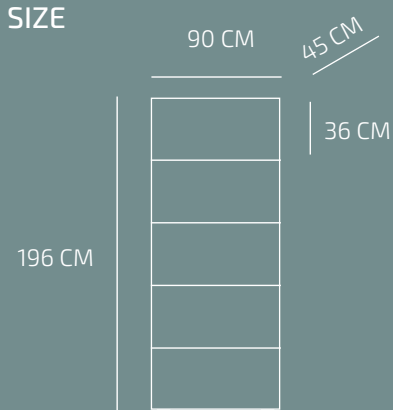

OPTIONS





DAN



SIZE

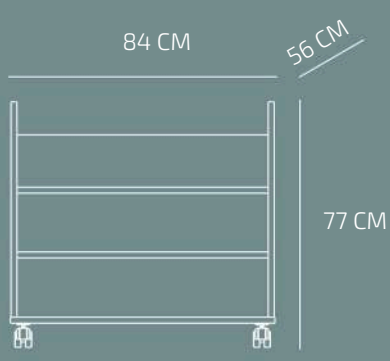

DETAILS





Complements

For a smoother experience.
Support tools designed to facilitate
collaborative learning dynamics and a fluid
and orderly cohabitation in the classroom.

Per a una experiència més fluida.
Eines de suport pensades per facilitar les
dinàmiques d'aprenentatge col·laboratiu i
una convivència fluida i ordenada a l'aula.



CONNECTIONS

CONCEPTS

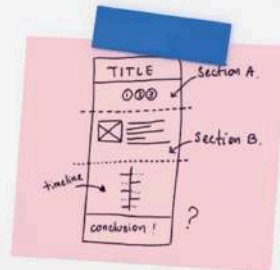
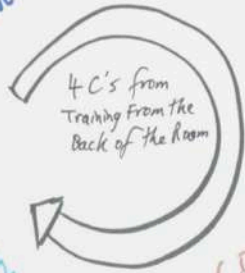

| NOVEMBER | | | | | | |
|----------|----|----|----|----|----|----|
| 1 | 2 | 3 | 4 | 5 | 6 | |
| 7 | 8 | 9 | 10 | 11 | 12 | 13 |
| 14 | 15 | 16 | 17 | 18 | 19 | 20 |
| 21 | 22 | 23 | 24 | 25 | 26 | 27 |
| 28 | 29 | 30 | | | | |

| MARCH | | | | | | |
|-------|----|----|----|----|----|----|
| 1 | 2 | 3 | 4 | 5 | | |
| 6 | 7 | 8 | 9 | 10 | 11 | 12 |
| 13 | 14 | 15 | 16 | 17 | 18 | 19 |
| 20 | 21 | 22 | 23 | 24 | 25 | 26 |
| 27 | 28 | 29 | 30 | 31 | | |

KEY LEARNINGS

RELATE TO WORK

CONCLUSIONS

CONCRETE PRACTICE

→ Active Participation

→ Collaborative Interdependence

Celebrate Learning





SIZE

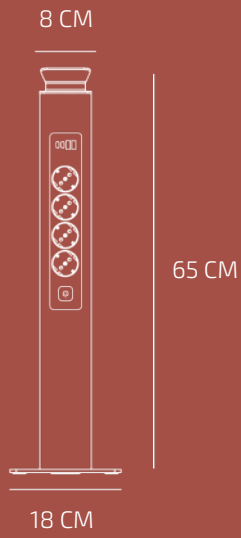

DETAILS



ODON





SIZE

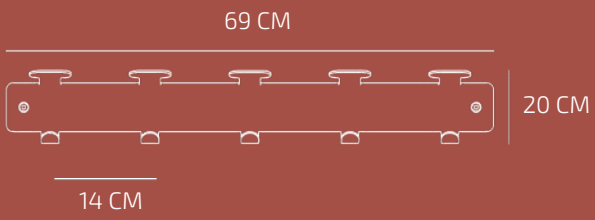

MARCUS



SIZE

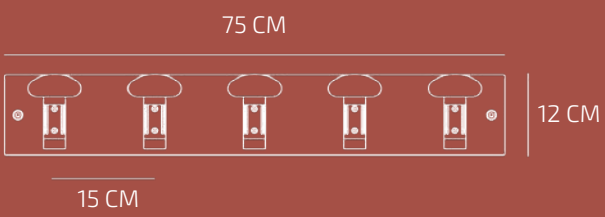

PEGGY





LILY



SIZE

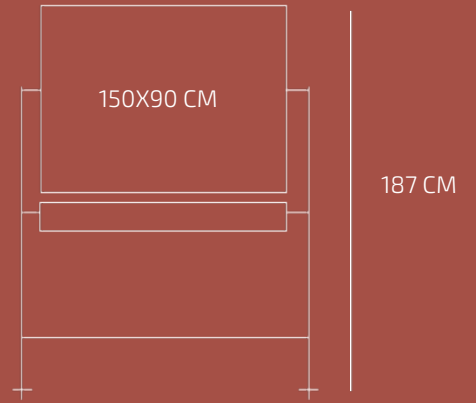

DETAILS



MINI LILY



Ref. 7029



SIZE

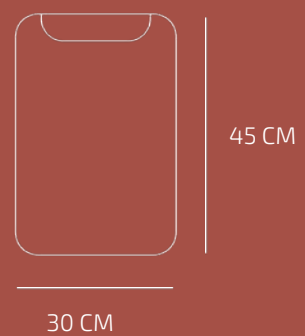

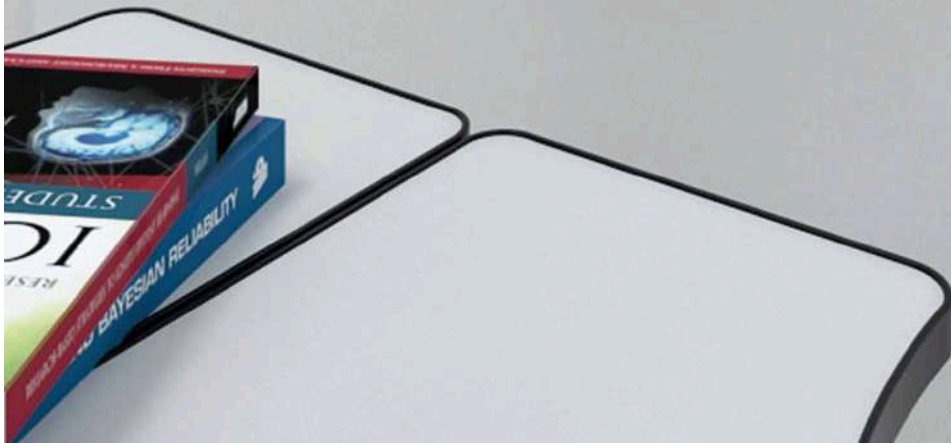

Classroom design service

mirplayschool.com

The team in Mirplay School helps you adapt your centre's learning spaces to the new educational dynamics taking place in it. Creating and optimising different spaces in a classroom, improving its acoustics and facilitating the orderly movement of students can be very easy.

With versatile furniture that is easy to move and store, comfortable and capable of coping with daily use, a wide range of possibilities opens up.

L'equip de Mirplay School t'ajuda a adaptar els espais d'aprenentatge del teu centre a les noves dinàmiques educatives que s'hi succeeixen. Crear i optimitzar diferents espais en una aula, millorar-ne l'acústica i facilitar el moviment ordenat dels alumnes pot ser molt senzill.

Amb mobiliari versàtil, fàcilment desplaçable i emmagatzemable, de disseny confortable i que absorbeixi el seu ús diari, s'obre un gran ventall de possibilitats.

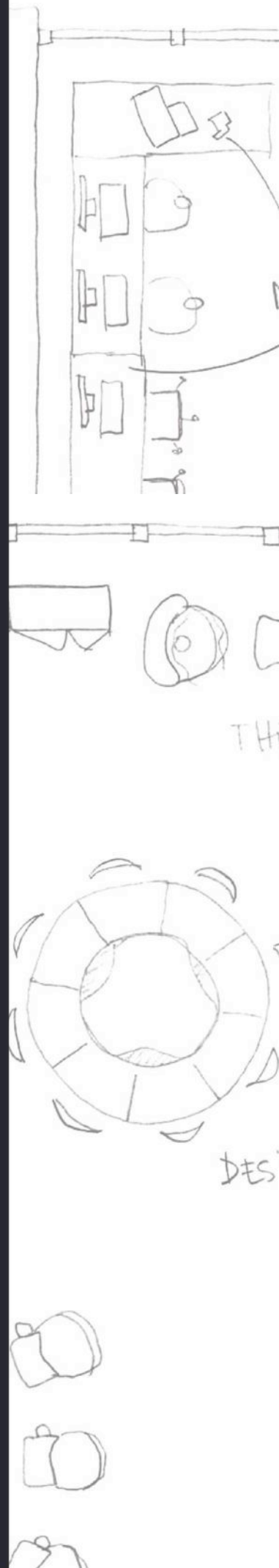

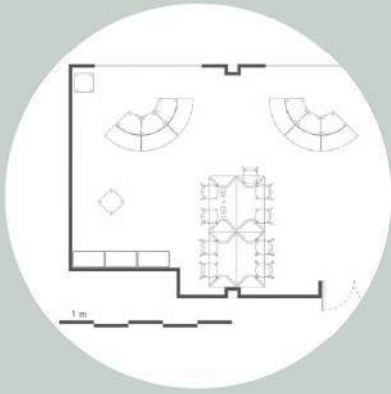

FLOOR LAYOUT DISTRIBUCIÓ EN PLANTA

We offer a proposal for the distribution of your space in a plan view, simple and easy to implement.

Et plantejgem una proposta de distribució del teu espai a una vista en planta, senzilla i fàcil de posar en pràctica.



3D VIEWS OF YOUR SPACE VISTES EN 3D DEL TEU ESPAI

Do you want to visualize how it will look like? You just have to tell us what the space is like, what you want to achieve and we will make you a proposal in 3D image.

Vols veure com quedarà? Només ens heu d'indicar com és l'espai, què voleu aconseguir i nosaltres us fem una proposta en imatge 3D.

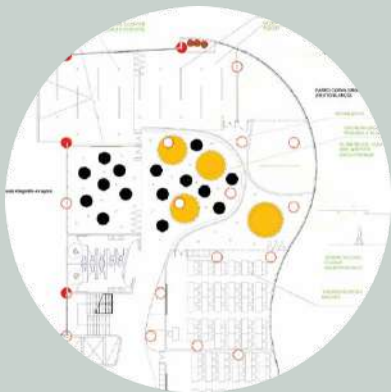

ARCHITECTURAL DRAFT AVANTPROJECTE ARQUITECTÒNIC

Our team of architects projects and adapts the space so that it supports and stimulates the activities that will take place in it.

El nostre equip d'arquitectes projecta i adapta l'espai perquè sostingui i dinamitzi les activitats que hi tindran lloc.



FURNISHING PROJECT PROJECTE DE DECORACIÓ

We guide you in interior design decisions to create a comprehensive decoration proposal.

T'acompanyem i guiem a les decisions d'interiorisme per crear una proposta integral de decoració.

JON
1045



p. 94

MIA BASIC
1028



p. 98

MIA CANTILEVER
1027



p. 99

MIA CASTORS
1029



p. 100

MIA MINI LIFT
169



p. 101

MIA LIFT
1035



p. 102

MIA BIG LIFT
1039



p. 103

MIA STOOL
1030



p. 104

MIA STORE
1038



p. 105

MIA TABLE
1036



p. 106

ZTOOL
1020



p. 108

ZTOOL TROLLEY
1037



p. 108

INA
1047



p. 111

ZOE
1044



p. 111

CHLOE



p. 114

CHARLOTTE
1041



p. 115

ANGLE
12001



p. 116

CUBE
12002



p. 116

TUBE
12003



p. 117

COMPLETE SOFA
12005



p. 117

MOVE
1608



p. 118

MINI MOVE
1609



p. 119

MOON
2362



p. 123

SQUARE
2341IN



p. 124

ARROW
2329IN



p. 125

HEXA
2336IN



p. 126

OCTA
2335IN



p. 127

YANG
2345R



p. 128

WAVE
2344R



p. 129

TRISIX
2346IN



p. 130

RECTANGLE
2352



p. 132

RECTANGLE PLUS
2353



p. 133

RECTANGLE TEACHER
2355D



p. 135

NAXEL
620



p. 136

QUAR ADJUSTABLE
622



p. 138

QUAR DOUBLE
ADJUSTABLE
623



p. 139

SPACE DESIGN
261



p. 141

SPACE PLUS
260



p. 142

ALUFLOOP
2048R



p. 146

MINIFLOOP
226DNR



p. 145

LOUISE
2354



p. 147

RONY
2221



p. 148

RONY
2220



p.148

TEO
2368



p. 151

VELVET
CR VELVET
CR

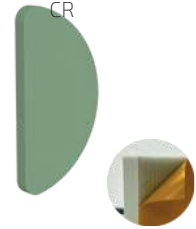

p. 154

VELVET
RF VELVET
RF

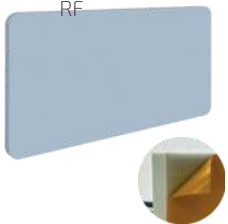

p. 154

VELVET
SQ VELVET
SQ



p. 155

VELVET
TR VELVET
TR



p. 155

SAMOS
2104



p. 156

ELEA
2105



p. 156

MARIE
732-601



p. 162

HEDY
532-501



p. 163

ADA
532-502



p. 163

JANE
632-504



p. 164

MERIT
632-507



p. 165

MERIT
632-508



p. 165

GRACE
632-501



p. 166

GRACE
632-503



p. 166

IRENE
533-501



p. 169

EMMY
533-502



p. 169

ANNIE
633-507



p. 170

ANNIE
633-509



p. 170

SOPHIE
633-501



p. 171

SOPHIE
633-503



p. 171

MILEVA
534-501



p. 172



FLORA
534-508



p. 172

INGE
534-509



p. 173

ELSA
634-508



p. 174

ALICE
634-510



p. 175

ALICE
634-512



p. 175

EMILIE
535-501



p. 176

MAUD
535-508



p. 176

ROSIE
535-521



p. 177

DAN
551



p. 178

ODON



p. 182

MARCUS
7028



p. 183

PEGGY
751



p. 183

LILY
4001



p. 184

MINI LILY
4002



p. 184

MINI LILY HOOK
7029



p. 184







FUTURE WORKPLACE

Your Furniture & Flooring Partner

LET'S CONNECT

Head Office Dubai

101, SKB Plaza, Sheikh Zayed Road, Dubai
PO Box: 452449

☎ Ph: +971 4 263 3521

✉ info@fwp.ae

🌐 www.fwp.ae

Abu Dhabi

546, Hanging Garden Tower, Hamdan Bin
Mohammed St - Al Danah, Abu Dhabi

☎ Ph: +971 2 667 3738

✉ info@fwp.ae

🌐 www.fwp.ae

Riyadh

King Abdullah Financial District
Riyadh, Kingdom of Saudi Arabia

☎ Ph: +971 52 600 5255

✉ info@fwp.ae

🌐 www.fwp.ae